

Singer 78-1

Form 8666—Revised
(137)

**LIST
OF
PARTS**



SINGER**

MACHINE No. 78-1

THE SINGER MANUFACTURING COMPANY

**A Trade Mark of THE SINGER MANUFACTURING COMPANY

From the library of: Diamond Needle Corp

INSTRUCTIONS FOR OILING

To ensure easy running and prevent unnecessary wear of the parts which are in movable contact, the machine requires oiling and when in continuous use, "TYPE B" or "TYPE D" OIL, sold by Singer Sewing Machine Company, should be applied at least twice each day to all oil holes marked "OIL", as instructed in Form 7974.

"TYPE D" OIL should be used when an oil is desired which will produce a minimum of stain on fabrics, even after a long period of storage.

Copyright, U. S. A., 1921, 1935, 1936 and 1937,
by The Singer Manufacturing Company
All Rights Reserved for all Countries

INDEX

	Page
Attachments and Accessories.....	11
Binders.....	11
Bobbin Winders.....	19
Corder.....	20
Edge Guide (Roller).....	23
Fittings.....	31
Foot Lifter Parts.....	22
Guide (Combination).....	23
Hammers.....	23
Knee Lifter Parts.....	25
Machine-No. 78-1.....	5
Needle Plates.....	26
Numerical List of Parts.....	29
Obsolete Parts.....	27
Piping Attachment on Shank.....	27
Presser Feet.....	27

From the library of Diamond Needle Corp

INSTRUCTIONS FOR ORDERING

In ordering from this list, use **ONLY** the part **NUMBER** in the **FIRST** column.

The number stamped on a Sewing Machine Part is in every case the number of the single part only.

Every combination of parts sent out as such has its specific number, which, although not stamped on the parts, must be used when ordering the combination.

Each number always indicates the **SAME PART** in whatever list it appears, or for whatever machine.

The letters after some of the numbers indicate the style of finish only, as follows:

- A-Hardened, Polished, Nickel Plated and Buffed
- B-Polished, Nickel Plated and Buffed
- C-Hardened Only
- D-Polished Only
- E-Soft, Not Polished
- F-Hardened and Polished

- F.J-Hardened, Polished and Nickel Plated
- G-Bright Rumbled and Nickel Plated
- H-Blued
- J-Nickel Plated Only
- K-Hardened and Nickel Plated
- L-Brass Plated
- M-Oxidized
- N-Japanned, Dull
- P-Japanned, Bright
- R-Merlized
- S-Cadmium Plating
- T-Copper Plated

- T.A-Hardened, Polished, Copper and Nickel Plated and Buffed
- T.B-Copper and Nickel Plated and Polished
- T.J-Copper and Nickel Plated Only
- T.K-Hardened, Copper and Nickel Plated
- T.M-Copper Plated and Oxidized
- T.L-Copper and Brass Plated
- U-Zinc Plated
- V-Silver Plated
- W-Polished and Nickel Plated
- Y-Black Nickel Plated Only
- Z-Chromium Plated
- Z.B-Polished, Nickel Plated, Buffed and Chromium Plated
- Z.J-Nickel and Chromium Plated

These letters **MUST BE USED** when they appear in the list; and **AFTER** the number as in the list.

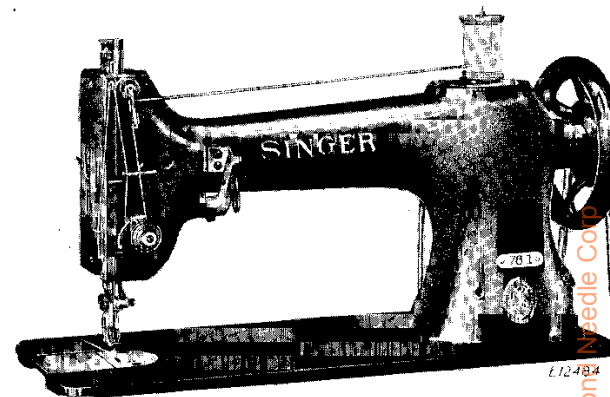
In this series:

- 1 to 1500, 50001 to 51500 and 140001 to 142000 are Screw Numbers
- 1501 to 1800 and 51501 to 51800 are Nut Numbers
- 1801 to 2000 and 51801 to 52000 are Roller Numbers
- 2001 to 50000 and 52001 to 140000 and 142001 to 190000 are Sewing Machine Parts, 190001 and upward are numbers of Electrical Parts.

The figures in the second column refer only to the plates, illustrating the parts, and are **NOT TO BE USED** in ordering.

Parts marked with an asterisk (*) are furnished only when repairs are made at factory.

LIST OF PARTS COMPLETE FOR



MACHINE No. 78-1

For Plain Stitching, Binding, Cording, Welting, Braiding, etc. For light work in harness, saddles, carriage trimming, adhesive material, cushion making, awnings, mattresses, tents, sails, heavy gloves and mittens and many other articles. Combined upper and needle feed; no under feed. Speed 1600 R. P. M.

NOTE: WHEN 78-1 MACHINE IS DESIRED FOR STRAW WORK, THE ORDER SHOULD SPECIFY LIFTING PRESSER FOOT (HINGED) NO. 37416 IN PLACE OF THE FOOT REGULARLY SUPPLIED.

No.	Plate	Name
*37363	----	Arm with 15404 and two 15405.....
8582	6143	" Dowel Pin.....
15783	----	" Oil Tube.....
11119	6143	" " " 15783 with 52045, for oiling Thread Take-up Lever.....
12454	6143	Arm Oil Tube with 132590, for oiling Thread Take-up Lever Link.....
52045	6143	Arm Oil Tube Packing (wick).....
132590	6161	" " " " (wick).....
748E	6143	" Screw (back).....
854E	6143	" " (front).....
37377	6154	" Shaft.....

PARTS FOR MACHINE NO. 78-I

No.	Plate	Name
12357	6144	Arm Shaft Flanged Bushing (back).....
448C	6143	" " " " Set Screw
37303	6144	" " " " (front).....
430C	6112	" " " " Set Screw
144D	6143	" " Screw.....
29505	6144	" Top Cover.....
29506	6144	Arm Top Cover complete, Nos. 29505, 29507 and 29601.....
4430	6143	Arm Top Cover Friction Washer.....
79C	6143	" " " Hinge Screw.....
29507	6143	" " " Spool Pin and Thread Eye- let.....
29601	6143	Arm Top Cover Spool Pin and Thread Eye- let Washer (steel).....
8879	6143	Arm Top Cover Spool Pin and Thread Eye- let Washer (cloth).....
4370	6154	Balance Wheel, heavy rim, 2 3/4 in. pulley, with two 448C.....
448C	6143	Balance Wheel Set Screw.....
37304	----	Bed.....
20197	6144	Crank Connecting Rod with two 896C.....
896C	6143	" " " Cap Screw.....
908C	6143	" " " Hinge Screw.....
1619J	6143	" " " " Nut....
37305	----	Face Plate with 37307.....
37306	6144	Face Plate complete, Nos. 2827 and 37305..
219F	6143	" " Screw.....
2827	6143	" " Thread Guard (lower) with 8505.....
8505	6143	Face Plate Thread Guard (lower) Rivet...
37307	6143	" " " (upper) with two 8505.....
8505	6143	Face Plate Thread Guard (upper) Rivet...
7299	6162	Feed Bar.....
37378	6103	" " Bell Crank.....
37379	6103	" " " Bracket with 1497C..
1497C	6103	" " " " Set Screw...
212D	6103	" " " " Cap Screw.....
37310	6103	" " " " Washer....
15170	6103	" " " " Slide Block.....
212D	6103	" " " " Cap Screw
37364	6103	" " Guide Bracket.....
37365	----	" " " Cap.....
37366	6103	" " " " 37365 with 37367.....
178F	6103	Feed Bar Guide Bracket Cap Screw.....
22372	6103	" " " " Slide Block.....
37367	----	" " " " " 22372 with 37368.....
37368	6103	Feed Bar Guide Bracket Slide Block Stud.
37314	6103	" " Socket Joint.....
37315	6103	" " " " Cap.....

PARTS FOR MACHINE NO. 78-I

No.	Plate	Name
179F	6103	Feed Bar Socket Joint Cap Screw.....
37369	6144	" Forked Connection.....
37317	6144	" Regulator Crank with 1813.....
2049	6145	" " " Pin.....
1813	6145	" " " Roller and Stud....
37318	6144	" " " Lever with 1057D.....
37319	----	" " " 37318 with 330D and 37320.....
165D	6145	Feed Regulator Lever Cap Screw.....
37320	6145	" " " Clamp.....
330D	6145	" " " " Screw.....
51224J	6145	" " " " Thumb Screw..
1057D	6145	" " " Clamping Screw....
37370	6162	" " " Segment.....
330D	6145	" " " " Screw.....
37322	6145	" " " Shaft.....
18055	6145	Feeding Foot Hinge Pin.....
37420	----	" " " Plate.....
37357	----	" " " Shank.....
37421	6163	Feeding Foot (hinged) complete for 37422 Nos. 18055, 37357 and 37420.....
190J	6145	Feeding Foot Screw.....
37023	6162	Lifting Presser Bar (hollow).....
37327	6145	" " " Connecting Link....
212D	6103	" " " " Cap Screw.....
37310	6103	Lifting Presser Bar Connecting Link Cap Screw Washer.....
37380	6145	Lifting Presser Bar Lifter.....
17542	6145	" " " " Hinge Pin...
37328	6144	" " " " Lifting Bracket with 453C.....
453C	6145	Lifting Presser Bar Lifting Bracket Set Screw.....
37408	6162	Lifting Presser Bar Spring.....
37025	6145	" " " " Pin.....
37422	6163	" " " Foot for 37421.....
Note: No. 37422 is sent with this Machine unless otherwise specified on order.		
18055	6145	Lifting Presser Foot Hinge Pin.....
37415	----	" " " " Plate.....
37357	----	" " " " Shank.....
37416	6168	Lifting Presser Foot (hinged) complete, for stitching brims of straw hats together, Nos. 18055, 37357 and 37415..
190J	6145	Lifting Presser Foot Screw.....
5681	6162	Needle Bar.....
37331	6112	" " Connecting Link with 794E....
794E	6112	" " " " Adjusting Screw.....
775E	6112	Needle Bar Connecting Link Cap Screw....
37332	6112	" " " Stud with 155C....

No.	Plate	Name
37348	----	Needle Bar Connecting Stud 37332 with 212D and 15170.....
155C	6112	Needle Bar Connecting Stud Set Screw....
37333	6162	" " Crank and Feed Cam with 858C and 1065C.....
1085C	6145	Needle Bar Crank and Feed Cam Position Screw.....
858C	6145	Needle Bar Crank and Feed Cam Set Screw.
4302	6147	" " Thread Guard.....
233J	6123	" " " Screw.....
4303	6147	" Clamp with 808F.....
808F	6145	" " Screw.....
37423	6147	" Plate (large needle hole) for 37381.....
37424	6147	Needle Plate (medium needle hole) for 37382.....
37381	6147	Needle Plate 37423 with 37384 and two 1161J.....
37382	6147	Needle Plate 37424 with 37384 and two 1161J.....
37384	6147	Needle Plate Thread Guard.....
1161J	6147	" " " " Screw.....
691F	6145	" " " " Screw.....
24104	6162	Oscillating Rock Shaft.....
24105	----	Oscillating Rock Shaft complete, Nos. 4784 12388 and 24104.....
12388	6162	Oscillating Rock Shaft Hinge Pin.....
448C	6143	" " " " "Set Screw
4784	6161	" " " " Oil Pad.....
12389	6169	" Shaft.....
37385	----	" " Crank.....
37386	6148	Oscillating Shaft Crank complete, Nos. 457C, 1518J, 19449 and 37385.....
3093	6161	Oscillating Shaft Crank Pin.....
457C	6161	" " " " Set Screw.....
19448	6148	" " " " Slide Block....
226J	6148	" " " " " Cap Screw.....
12424	6148	Oscillating Shaft Crank Slide Block Cap Screw Washer.....
988C	6148	Oscillating Shaft Crank Slide Block Screw Stud.....
1518J	6148	Oscillating Shaft Crank Slide Block Screw Stud Nut.....
19449	----	Oscillating Shaft Crank Slide Block complete, Nos. 226J, 988C, 12424 and 19448.
1210E	6161	Pressure Regulating Thumb Screw.....
2996	6148	Shuttle Bobbin.....
224840	----	" " Case with 2523 and 7553..
15140	6148	" " " " Latch.....
2973	6148	" " " " Lever.....
2974	6148	" " " " Fulcrum Pin

No.	Plate	Name
2975	6148	Shuttle Bobbin Case Latch Spring.....
592E	6148	" " " " Stop Screw....
15141	----	" " " " Hinge, Nos. 2973, 2974 and 15140.....
*7553	6148	Shuttle Bobbin Case Position Finger....
2523	6148	" " " " " Rivet.
37373	6162	" " " " " Plate.....
391J	6148	" " " " " Screw.
224841	6148	Shuttle Bobbin Case complete, Nos. 591F, 592E, 2975, 15141, 224840 and 224842...
37854	6148	Shuttle Body.....
591F	6148	" Tension Regulating Screw.....
224842	6148	" " Spring.....
37855	6148	" " 1 11/16 in. diam. Nos. 2996, 37854 and 224841.....
*37371	----	Shuttle Driver.....
37372	6148	" " 37371 with two 462C....
2049	6145	" " Pin.....
462C	6161	" " Set Screw.....
2531	6109	" Race Back.....
2532	6109	" " " Position Pin.....
2533	6109	" " " Spring.....
648D	6109	" " " Screw.....
37360	----	" " Body.....
37405	----	" " " 37360 with 37361 and two 1053D.....
37361	6109	Shuttle Race Cap.....
1053D	6109	" " " Screw.....
37374	6109	Shuttle Race complete, Nos. 648D, 2531, 2533 37373, 37405 and two each 391J and 2532.....
145E	6109	Shuttle Race Screw.....
12431	----	" " Slide.....
12432	6162	Shuttle Race Slide complete, Nos. 4307, 12431 and two 725E.....
4307	6162	Shuttle Race Slide Spring.....
725E	6150	" " " " Screw.....
2102	3471	Tension Disc.....
1580C	6161	" Regulating Thumb Nut.....
32572	6161	" Releasing Disc.....
37375	6162	" " Lever.....
37387	6162	" " " Connection.....
37388	6162	" " " " Extension
190J	6145	" " " " " Screw.....
7071	6121	Tension Releasing Lever Connection Extension Screw Washer.....
8285	6161	Tension Releasing Lever Hinge Pin.....
24143	6161	" " " Spring.....
32574	6161	" " Pin.....
1274C	6161	" Screw Stud.....
2103	6161	" Spring.....

No.	Plate	Name
12149	6161	Tension Thread Guard.....
37404	----	Tension complete, Nos. 1274C, 1560C, 2103, 8511, 32572, 32574, 37351 and two 2102.
24078	6150	Thread Guard (side of arm).....
52454	6150	" Retainer.....
624C	6161	" " Set Screw.....
37389	6112	" Take-up Crank.....
3094	6112	" " " Wedge.....
890E	6112	" " " Screw.....
37343	6112	" " Lever.....
12166	6112	" " " Hinge Pin.....
37344	6112	" " " Link.....
11204	6112	" " " " Hinge Pin.....
430C	6112	" " " " " Set Screw.....
37345	----	Thread Take-up Lever complete, Nos. 12166, 37343 and 37344.....
8511	6150	Thread Take-up Spring (music wire).....
37351	6150	" " " Regulator.....
446C	6150	" " " " Set Screw
15404	----	Trade Mark.....
15405	----	" " Rivet.....
44212	6154	Drip Pan with four 1 in. wire nails.....

SINGER Needles should be used
in **SINGER** Machines
These Needles and their Containers
are marked with the
Company's Trade Mark "SIMANCO.**" 1

Needles in Containers marked
"FOR SINGER MACHINES"
are NOT **SINGER** made needles. 2

ATTACHMENTS AND ACCESSORIES

No.	Plate	Name
12361	6150	Machine Hinge Connection.....
44139	6150	" " Plate.....
44140	----	Machine Hinge complete, Nos. 12361, 44139 and marlized wood screw 1 1/4 in. No. 14.....
12405	6150	Machine Rest (felt).....
41400	6120	" " Pin (wood) 3 1/8 in. long..
120342	6120	Oiler (copper plated) with 120343.....
120343	6120	" Spout, 3 1/2 in. long.....
28028	6120	Screw Driver (machine).....
28485	6120	" " (shuttle tension).....
8909	6120	Wrench for 1518.....
19221	6120	" " 1619.....

BINDERS

BINDER (English)

No.	Plate	Name
36228	6121	Binder Folder with 665J and 36229.....
36229	6121	" " Guide.....
665J	6121	" " " Screw.....
220J	6151	" " " Screw.....
7806	6151	" " " Washer.....
26614	6121	" Ribbon Tension Pin (bent).....
26615	6121	" " " " (straight).....
36230	6121	" " " " Plate.....
36231	6121	Binder Ribbon Tension complete, Nos. 26614 36230 and six 26615.....
190J	6145	Binder Ribbon Tension Screw.....
7071	6121	" " " " Washer.....
36232	6128	Feeding Foot.....
36233	6128	Lifting Presser Foot.....
36234	----	Binder (English) complete, Nos. 220J, 7806, 36228, 36231 to 36233 and two each 190J and 7071.....

BINDER ON SHANK

FOR MATTRESS WORK

No.	Plate	Name
36235	----	Binder.....
220J	6151	" Adjusting Screw.....
7806	6151	" " " Washer.....

From the Library of Diamond Needle Corp.

BINDER ON SHANK

No.	Plate	Name
36236	----	Binder Shank.....
36237	6122	Binder on Shank complete, Nos. 36235, 36236 and two each 220J and 7806.....
190J	6145	Binder Screw.....
7071	6121	" " Washer.....
36238	6122	Feeding Foot.....
36239	6122	Lifting Presser Foot.....

BINDER ON SHANK

FOR FURNITURE SLIP COVERS

No.	Plate	Name
36240	----	Binder.....
220J	6151	" Adjusting Screw.....
7806	6151	" " Washer.....
36241	----	" Shank.....
36242	6122	Binder on Shank complete, Nos. 36240, 36241 and two each 220J and 7806.....
190J	6145	Binder Screw.....
7071	6121	" " Washer.....
36238	6122	Feeding Foot.....
36239	6122	Lifting Presser Foot.....

BINDER ON SHANK

FOR ENAMELLED BINDING FOR CHAIR BOTTOMS,
SEAT CURTAINS OR OTHER SIMILAR WORK

No.	Plate	Name
36243	----	Binder.....
233J	6123	" Adjusting Screw.....
36244	----	" Shank.....
36245	6123	Binder on Shank complete, Nos. 36243, 36244 and two 233J.....
190J	6145	Binder Screw.....
7071	6121	" " Washer.....
37326	6123	Feeding Foot.....
36246	6123	Lifting Presser Foot.....

BINDER ON SHANK

FOR BIAS BINDING, FOR TURNING UNDER BOTH
EDGES OF BINDING FOR GENERAL WORK

No.	Plate	Name
36247	----	Binder.....
233J	6123	" Adjusting Screw.....
36244	----	" Shank.....
36248	6124	Binder on Shank complete, Nos. 36244, 36247 and two 233J.....
190J	6145	Binder Screw.....
7071	6121	" " Washer.....
37326	6123	Feeding Foot.....
36249	6124	Lifting Presser Foot.....

BINDER ON SHANK

FOR BIAS BINDING, TO TURN UNDER THE TOP EDGE ONLY
FOR SUSPENDER ENDS AND OTHER SIMILAR WORK

No.	Plate	Name
36250	----	Binder.....
233J	6123	" Adjusting Screw.....
7806	6151	" " Washer.....
36251	----	" Shank.....
36252	6125	Binder on Shank complete, Nos. 233J, 7806, 36250 and 36251.....
190J	6145	Binder Screw.....
7071	6121	" " Washer.....
37326	6123	Feeding Foot.....
36253	6125	Lifting Presser Foot.....

BINDER ON SHANK

FOR BINDING WITH BRAID FOR GENERAL WORK

No.	Plate	Name
36254	----	Binder.....
233J	6123	" Adjusting Screw.....
7806	6151	" " Washer.....
36255	----	" Shank.....
36256	6124	Binder on Shank complete, Nos. 233J, 7806, 36254 and 36255.....
190J	6145	Binder Screw.....

BINDER ON SHANK

No.	Plate	Name
7071	6121	Binder Screw Washer.....
37326	6123	Feeding Foot.....
36249	6124	Lifting Presser Foot.....

BINDER ON SHANK

FOR LIGHT LEATHER OR OILCLOTH BINDING FOR LEATHER

No.	Plate	Name
36268	----	Binder.....
233J	6123	" Adjusting Screw.....
7806	6151	" " " Washer.....
1835	6126	" Roller.....
1521J	6126	" " Nut.....
36269	----	" Shank.....
36270	6126	Binder on Shank complete, Nos. 1521J, 1835, 36268, 36269 and two each 233J and 7806.....
190J	6145	Binder Screw.....
7071	6121	" " Washer.....
36271	6126	Feeding Foot.....
36272	6126	Lifting Presser Foot.....

BINDER ON SHANK

FOR BINDING COMFORTABLES

No.	Plate	Name
36368	6127	Binder.....
197J	6127	" Adjusting Screw.....
7071	6121	" " " Washer.....
36369	6127	" Shank.....
36370	----	Binder on Shank complete, Nos. 36368, 36369 and two each 197J and 7071.....
190J	6145	Binder Screw.....
7071	6121	" " Washer.....
36371	6127	Feeding Foot.....
36372	6127	Lifting Presser Foot.....

BINDER ON SHANK

FOR BINDING TWO PIECES OF LEATHER WITH
THIN LEATHER BINDING

No.	Plate	Name
36406	----	Binder.....

BINDER ON SHANK

No.	Plate	Name
220J	6151	Binder Adjusting Screw.....
7806	6151	" " " Washer.....
36236	----	" Shank.....
36407	6130	Binder on Shank complete, Nos. 36236, 36406 and two each 220J and 7806.....
190J	6145	Binder Screw.....
7071	6121	" " Washer.....
37326	6123	Feeding Foot.....
36249	6124	Lifting Presser Foot.....

BINDER ON SHANK

FOR BINDING TICKET HOLDERS WITH IMITATION
LEATHER BINDING

No.	Plate	Name
36409	----	Binder.....
220J	6151	" Adjusting Screw.....
7806	6151	" " " Washer.....
36255	----	" Shank.....
36410	6128	Binder on Shank complete, Nos. 220J, 7806, 36255 and 36409.....
190J	6145	Binder Screw.....
7071	6121	" " Washer.....
36232	6128	Feeding Foot.....
36233	6128	Lifting Presser Foot.....

BINDER ON SHANK

FOR GENERAL WORK, FOR FIRST LINE OF STITCHING, FOR BINDING
WITH TAPE, LOWER PART OF BINDING TO EXTEND
UNDER FOR SECOND LINE OF STITCHING

No.	Plate	Name
36411	----	Binder.....
220J	6151	" Adjusting Screw.....
7806	6151	" " " Washer.....
36236	----	" Shank.....
36412	6163	Binder on Shank complete, Nos. 36236, 36411 and two each 220J and 7806.....
190J	6145	Binder Screw.....
7071	6121	" " Washer.....
18055	6145	Feeding Foot Hinge Pin.....
37420	----	" " Plate.....
37357	----	" " Shank.....

BINDER ON SHANK

No.	Plate	Name
37421	6163	Feeding Foot (hinged) complete, Nos. 18055 37357 and 37420.....
37422	6163	Lifting Presser Foot.....

BINDER ON SHANK

FOR HEAVY SEAMS

No.	Plate	Name
121470	6156	Binder.....
233J	6123	" Adjusting Screw.....
7806	6151	" " Washer.....
121471	6156	" Shank.....
121472	6156	Binder (adjustable) on Shank complete, Nos. 121470, 121471 and two each 233J and 7806.....
190J	6145	Binder Screw.....
7071	6121	" " Washer.....
36232	6128	Feeding Foot.....
36233	6128	Lifting Presser Foot.....

BINDER ON SHANK

FOR OILCLOTH

No.	Plate	Name
121473	6157	Binder.....
220J	6151	" Adjusting Screw.....
7806	6151	" " Washer.....
36236	----	" Shank.....
121474	6157	Binder (adjustable) on Shank complete, Nos. 36236, 121473 and two each 220J and 7806.....
190J	6145	Binder Screw.....
7071	6121	" " Washer.....
36232	6128	Feeding Foot.....
36233	6128	Lifting Presser Foot.....

BINDER (English)

FOR IMITATION BINDING OF SUITCASE WORK

No.	Plate	Name
121475	6158	Binder Folder.....
1442J	6158	" " Screw.....
121476	6158	" Plate.....

BINDER (English)

No.	Plate	Name
26617	6158	Binder Ribbon Tension Pin (bent).....
26486	6158	" " " (straight)....
26618	6158	" " " Plate.....
25734	6158	Binder Ribbon Tension complete, Nos. 26617 26618 and seven 26486.....
190J	6145	Binder Ribbon Tension Screw.....
7071	6121	" " " Washer.....
50004B	6158	" Screw.....
121478	6157	Feeding Foot.....
121479	6157	Lifting Presser Foot.....
121480	6157	Needle Plate for 121481.....
121481	6157	" " 121480 with 37384 and two 1161J.....
37384	6147	Needle Plate Thread Guard.....
1161J	6147	" " " Screw.....
121477	----	Binder (English) complete, Nos. 1442J, 25734, 121475, 121476, 121478, 121479, 121481 and two each 190J, 7071 and 50004B.....

BINDER (English)

FOR CANVAS WORK

No.	Plate	Name
121482	6159	Binder.....
207J	6159	" Adjusting Screw.....
121483	6159	" Plate.....
228J	6159	" Screw.....
36232	6128	Feeding Foot.....
36233	6128	Lifting Presser Foot.....
121485	6159	Needle Plate.....
121486	6159	" " 121485 with 37384 and two 1161J.....
37384	6147	Needle Plate Thread Guard.....
1161J	6147	" " " Screw.....
121484	----	Binder (English) complete, Nos. 228J, 36232 36233, 121482, 121483, 121486 and two 207J.....

BINDER (Transverse)

FOR BINDING LEATHER SHOES

No.	Plate	Name
121487	6160	Binder (transverse).....
50163J	6160	" Adjusting Screw.....
121488	6160	" Plate.....

Library of: Diamond Needle Co.

BINDER (Transverse)

No.	Plate	Name
1423J	6160	Binder Plate Screw.....
36232	6128	Feeding Foot.....
36233	6128	Lifting Presser Foot.....
121490	6160	Needle Plate.....
121491	6160	" " 121490 with 37384 and two 1161J.....
37384	6147	Needle Plate Thread Guard.....
1161J	6147	" " " Screw.....
121489	----	Binder (transverse) complete, Nos. 1423J, 36232, 36233, 121487, 121488, 121491 and two 50163J.....

BINDER ON SHANK
FOR BIAS CUT BINDING

No.	Plate	Name
121552	----	Binder.....
787J	6181	" Adjusting Screw.....
7806	6151	" " " Washer.....
121553	----	" Shank.....
121554	6164	Binder on Shank complete, Nos. 121552, 121553 and two each 787J and 7806....
190J	6145	Binder Screw.....
7071	6121	" " Washer.....
37326	6123	Feeding Foot.....
36253	6125	Lifting Presser Foot.....

BINDER ON SHANK
FOR HAT RIMS

No.	Plate	Name
121555	----	Binder.....
226J	6148	" Adjusting Screw.....
121556	----	" Shank.....
121557	6165	Binder on Shank complete, Nos. 121555, 121556 and two 226J.....
190J	6145	Binder Screw.....
7071	6121	" " Washer.....
36232	6128	Feeding Foot.....
121558	6168	Lifting Presser Foot.....

BOBBIN WINDERS

BOBBIN WINDER

(SWINGING AUTOMATIC, RIGHT HAND)

FOR 2996

FOR POWER TABLE

No.	Plate	Name
225433	6169	Bobbin Winder and Tension Bracket Base..
225453	22395	Frame with 202277 and 225433.....
225454	3471	" Hinge Pin.....
202277	3471	" Oil Packing (wick).....
225438	3471	" " Well Cap.....
225455	3471	" Spring.....
225458	3471	" Plunger.....
202473	6169	Pulley with 200380C.....
200380C	3471	" Set Screw.....
225381	22395	Spindle.....
225444	3471	Stop Latch.....
200056E	3471	" " Screw.....
225458	3471	" " Thumb Lever.....
225459	3471	" " " Hinge Stud.....
225459	3471	" " " Joint Stud.....
202478	3471	" " Trip Lever.....
200299H	3471	" " " Hinge Screw.....
225461	3471	Tension Bracket with 201499B.....
200082D	3471	" " Screw.....
228026	6161	" " " Washer.....
2102	3471	" Disc.....
202407	3471	" Spring.....
201499B	3471	" Stud.....
201572B	3471	" " Thumb Nut.....
225462	----	Tension Bracket complete, Nos. 201572B, 202407, 225461 and two 2102.....
225382	6169	Bobbin Winder (swinging automatic, right hand) complete, Nos. 200056E, 200082D, 200299H, 202473, 202478, 225381, 225433, 225444, 225453 to 225456, 225458, 225462, 228026 and two each 225459 and wood screws 3/4 in. No. 12 R.H.B..

BOBBIN WINDER

(SWINGING AUTOMATIC, RIGHT HAND)

FOR 2996

FOR STAND

No.	Plate	Name
27540	22395	Base.....

BOBBIN WINDER

No.	Plate	Name
15072	6150	Bobbin Position Pin.....
27302	22395	Frame.....
50356D	6150	" Hinge Screw.....
1620J	6150	" " " Nut.....
27303	6161	" Spring.....
27541	22395	Pulley.....
*27849	----	Spindle.....
27538	22395	" 27849 with 15072,27850 and 41828
*27850	6150	" Collar.....
41828	6150	" Pin.....
27306	22395	Spool Pin.....
27307	22395	" Stand.....
27308	22395	Spool Stand complete, Nos. 418E, 1562J, 210E 10141, 11241, 27306, 27307 and two each 2455 and wood screws 1 in. No. 10...
11241	22395	Spool Washer (cloth).....
27312	22395	Stop Latch.....
35D	6150	" Hinge Screw.....
2455	6151	Tension Disc.....
1562J	6151	" Regulating Thumb Nut.....
418E	6151	" Screw Stud.....
10141	6151	" Spring.....
210E	6151	" Thread Guide.....
27647	22395	Bobbin Winder, Nos. 35D, 1620J, 27302, 27303, 27312, 27538, 27540, 27541, 50356D and two wood screws 1 in. No. 7.....
27544	----	Bobbin Winder (swinging automatic, right hand) complete, Nos. 27308 and 27647

CORDER

FOR BUGGY CUSHIONS

No.	Plate	Name
36275	6132	Cord Guide with 580E.....
36276	6132	" " Arm.....
36277	6132	" " " Adjusting Plate.....
219F	6143	" " " " Screw....
7071	6121	" " " " " Washer
940J	6132	" " " Hinge Screw.....
36278	6132	" " Bed.....
580E	6132	" " Position Pin.....
219F	6143	" " Screw.....
36279	6132	Corder complete, Nos. 940J, 7071, 36275 to 36278 and two 219F.....
190J	6145	Corder Screw.....
7071	6121	" Washer.....
36280	6132	Feeding Foot.....
36281	6132	Lifting Presser Foot.....

Note: When ordering Nos. 36280 or 36281, state the size or send sample of cord for which it is to be used.

FITTINGS

FITTINGS FOR BRAIDING

No.	Plate	Name
36273	6131	Braid Guide (front of arm).....
217J	6131	" " Screw.....
36274	6131	Feeding Foot.....
37330	6131	Lifting Presser Foot (double).....

Note: When ordering Nos. 36274 or 37330, state the size or send sample of braid for which it is to be used.

FITTINGS FOR CORDING

No.	Plate	Name
36260	6131	Feeding Foot for 36261.....
36261	6131	Lifting Presser Foot for 36260.....
36280	6132	Feeding Foot for 121496.....
121496	6167	Lifting Presser Foot for 36280.....

Note: When ordering Nos. 36260, 36261, 36280 or 121496, state the size or send sample of cord for which it is to be used.

FITTINGS FOR INSERTING CORD OR REED
ON LEATHER, FOR HARNESS WORK

No.	Plate	Name
36282	6137	Feeding Foot.....
36283	6137	Lifting Presser Foot with 230H.....
36284	6137	" " " Guide with 36285...
36285	6137	" " " " Bushing.....
36286	6137	" " " " Spring.....
36287	6137	" " " " Washer.
36288	6137	" " " " Stud.....
1550H	6137	" " " " Nut.....
230H	6136	" " " " Set Screw
36289	6137	Lifting Presser Foot with Spring Guide complete, Nos. 1550H, 36283, 36284 and 36286 to 36288.....
28658	6137	Guide (roller) with 1852.....
1852	6137	" Roller.....
284J	6145	" Thumb Screw.....

Note: When ordering Nos. 36282 or 36289, state size or send sample of material for which it is to be used.

FOOT LIFTER PARTS

No.	Plate	Name
5596	6166	Bell Crank.....
56848	----	" " 5596 with 5599 and 5601.....
5599	6166	" " Bracket.....
178E	6103	" " " Screw.....
5601	6151	" " Hinge Pin.....
5735	6166	" " Spring.....
5598	6166	Bell Crank complete, Nos. 5735 and 56848..
5670	----	Chain, length 26 in. to 35 in., with 56864 and 56865.....
Note: When ordering No. 5670, state length required.		
4879	6151	Chain Connecting Link.....
56864	6151	" Hook (large).....
56865	6151	" (small).....
37346	6169	Lifting Lever with 453C.....
12415	6144	" " Connecting Rod.....
12416	6151	" " " " Joint.....
76D	6151	" " " " Hinge Screw.....
1521E	6126	Lifting Lever Connecting Rod Lock Nut...
802D	6150	" " Hinge Screw.....
37390	6151	" " Link.....
766D	6151	" " Hinge Screw.....
4727	6151	" " Pin.....
453C	6145	" " Set Screw.....
2763	22161	Rock Shaft.....
12242	22161	" " Hanger with two wood screws 1 in. No. 10.....
6337	22161	Rock Shaft Lifting Bracket with two 356C
12243	22161	" " " " Hook.....
7125	22161	" " " " Hook.....
356C	6151	" " " " Set Screw
356C	6151	" " " " Set Screw....
2770	22161	" " Stop Dog with 356C.....
356C	6151	" " Set Screw.....
4880	22161	Rock Shaft complete, Nos. 2763, 2770, 7125, 12243 and two each 6337 and 12242...
4881	6169	Treadle.....
4882	6166	" Shaft.....
4883	6166	" Spring.....
4884	6169	" Stand.....
4885	6169	Treadle complete, Nos. 4879, 4881 to 4884 and two wood screws 1 in. No. 16....
37392	----	Foot Lifter complete, Nos. 76D, 766D, 802D, 1521E, 4727, 4880, 4885, 5598, 5670, 12415 12416, 37346, 37390 and two 178E.....

GUIDE (Combination)

No.	Plate	Name
26873	6166	Guide (combination).....
284J	6145	" Thumb Screw.....
3146	6161	" " " Washer.....

EDGE GUIDE (Roller)

No.	Plate	Name
26803	6139	Edge Guide Bed with 2362.....
220J	6151	" " Leveling Screw.....
36775	6139	" " Slide with 26809, 51809 and two 12152.....
26805	6139	Edge Guide Slide Cap (left).....
207F	6159	" " " " " Screw.....
2362	6139	" " " " " Steady Pin...
26806	6139	" " " " (right).....
207F	6159	" " " " " Screw (large)
233J	6123	" " " " " (small)
26807	6139	" " " Lever.....
94D	6139	" " " Hinge Screw.....
51809	6139	" " " Roller and Stud.....
26808	6139	" " " Spring.....
26809	6139	" " " Cover.....
12152	6139	" " " Rivet....
36291	6139	Edge Guide (roller) complete, Nos. 94D, 233J, 26803, 26805 to 26808, 36775, two 207F and four 220J.....
190J	6145	Edge Guide Screw.....
37326	6123	Feeding Foot.....
36253	6125	Lifting Presser Foot.....

HEMMERS

HEMMERS (Suspended) FOR FLAGS

No.	Plate	Name
36257	6133	Hemmer.....
580J	6133	" Adjusting Screw.....
1549J	6133	" " " Nut.....

HEMMERS

No.	Plate	Name
36258	6133	Hemmer Bracket.....
190J	6145	" " Screw.....
7071	6121	" " " Washer.....
2818	6133	" Friction Washer.....
77J	6133	" Hinge Screw.....
36259	6133	Hemmer (suspended) complete, Nos. 77J, 580J 1549J, 2818, 36257 and 36258.....
37326	6123	Feeding Foot.....
36249	6124	Lifting Presser Foot.....

HEMMER ON SHANK

FOR CANVAS, ENAMELLED CLOTH, THIN LEATHER, ETC.

No.	Plate	Name
36262	----	Hemmer.....
220J	6151	" Adjusting Screw.....
7806	6151	" " " Washer.....
36236	----	" Shank.....
36263	6134	Hemmer on Shank complete, Nos. 36236, 36262 and two each 220J and 7806.....
190J	6145	Hemmer Screw.....
7071	6121	" " " Washer.....
37326	6123	Feeding Foot.....
36264	6134	Lifting Presser Foot.....

HEMMER ON SHANK

FOR 2 IN. TO 4 IN. HEM, FOR SHEETS

No.	Plate	Name
36265	6135	Hemmer.....
230D	6136	" Adjusting Screw.....
8068	6136	" " " Washer.....
36266	6136	" Shank.....
36267	----	Hemmer on Shank complete, Nos. 36265, 36266 and two each 230D and 8068.....
190J	6145	Hemmer Screw.....
7071	6121	" " " Washer.....
37326	6123	Feeding Foot.....
36264	6134	Lifting Presser Foot.....

HEMMER ON SHANK

FOR CANVAS

No.	Plate	Name
120036	----	Edge Folder.....
226J	6148	" " Adjusting Screw.....
120037	----	" " Shank.....
120038	6165	Edge Folder on Shank complete, Nos. 120036 120037 and two 226J.....
190J	6145	Edge Folder Screw.....
7071	6121	" " " Washer.....
120039	----	Hemmer.....
226J	6148	" Adjusting Screw.....
120040	----	" Shank.....
120041	6165	Hemmer on Shank complete, Nos. 120039, 120040 and two 226J.....
190J	6145	Hemmer Screw.....
7071	6121	" " " Washer.....

HEMMER (Adjustable) ON SHANK

FOR CANVAS WORK

No.	Plate	Name
121492	6156	Hemmer Folder (lower).....
121493	6156	" " (upper).....
725J	6150	" (adjusting) Screw.....
121494	6156	" Shank.....
121495	6156	Hemmer (adjustable) on Shank complete, Nos. 121492 to 121494 and four 725J..
190J	6145	Hemmer Screw.....
7071	6121	" " " Washer.....
36232	6128	Feeding Foot.....
36233	6128	Lifting Presser Foot.....

KNEE LIFTER PARTS

No.	Plate	Name
5596	6166	Bell Crank.....
56848	----	" " 5596 with 5599 and 5601.....
5599	6166	" " Bracket.....
178E	6103	" " " Screw.....
5601	6151	" " Hinge Pin.....
5735	6166	" " Spring.....
5598	6166	Bell Crank complete, Nos. 5735 and 56848..
37346	6169	Lifting Lever with 453C.....

KNEE LIFTER PARTS

No.	Plate	Name
12415	6144	Lifting Lever Connecting Rod.....
12416	6151	" " " " Joint.....
76D	6151	" " " " Hinge Screw.....
1521E	6126	Lifting Lever Connecting Rod Lock Nut...
802D	6150	" " Hinge Screw.....
37390	6151	" " Link.....
766D	6151	" " Hinge Screw.....
4727	6151	" " Pin.....
453C	6145	" " Set Screw.....
2763	22161	Rock Shaft.....
7539	22161	" " Hanger with two wood screws 1 in. No. 10.....
2765	22161	Rock Shaft Knee Arm.....
2766	22161	" " " " Hub with 356C.....
356C	6151	" " " " Set Screw.....
2768	----	Rock Shaft Knee Arm complete, Nos. 2765 to 2767.....
2767	22161	Rock Shaft Knee Plate with 356C.....
356C	6151	" " " " Set Screw.....
6337	22161	" " Lifting Bracket with two 356C
2778	22161	" " " " Hook.....
356C	6151	" " " " Set Screw
356C	6151	" " " " Set Screw....
2770	22161	" " Stop Dog with 356C.....
356C	6151	" " " " Set Screw.....
12250	22161	Rock Shaft complete, Nos. 2763, 2766, 2778, 6337 and two each 2770 and 7539.....
37393	----	Knee Lifter complete (power table or stand) Nos. 76D, 766D, 802D, 1521E, 4727, 5598, 12250, 12415, 12416, 37348, 37390 and two 178E.....

NEEDLES PLATES

No.	Plate	Name
37399	6167	Needle Plate, large needle hole, with 37401 and two 229J.....
37383	----	Needle Plate, small needle hole, with 37384 and two 1161J.....
37400	----	Needle Plate, small needle hole, with 37401 and two 229J.....
37401	6167	Needle Plate Needle Guard.....
229J	6167	" " " " Screw.....
37384	6147	" " Thread Guard.....
1161J	6147	" " " " Screw.....

PIPING ATTACHMENT ON SHANK

FOR FURNITURE UPHOLSTERING

No.	Plate	Name
121559	----	Piping Attachment.....
236J	6161	" " Adjusting Screw.....
121560	----	" " Shank.....
121561	6165	Piping Attachment on Shank complete, Nos. 121559, 121560 and two 236J.....
190J	6145	Piping Attachment Screw.....
7071	6121	" " Washer.....
36280	6132	Feeding Foot.....
36281	6132	Lifting Presser Foot.....

PRESSER FEET

No.	Plate	Name
18055	6145	Feeding Foot Hinge Pin.....
37418	----	" " Plate.....
37324	----	" " Shank.....
37419	6168	Feeding Foot (hinged) complete for 37422 Nos. 18055, 37324 and 37418.....
18055	6145	Feeding Foot Hinge Pin.....
37353	----	" " Plate.....
37324	----	" " Shank.....
37354	6168	Feeding Foot (hinged) complete, for thin material, Nos. 18055, 37324 and 37353..
37326	6123	Feeding Foot for 37330.....
37397	6168	" " " 37398.....
190J	6145	" " Screw.....
37398	6168	Lifting Presser Foot for 37397.....
37330	6131	" " " (double) for 37326..
190J	6145	" " " Screw.....

OBSOLETE PARTS

No.	Plate	Name
20021	----	Drip Pan with four 1 in. wire nails, use 44212.....
37356	----	Feeding Foot Plate for 37358.....
37358	----	Feeding Foot (hinged) complete, for auto- mobile work, Nos. 18055, 37356 and 37357, use 37421.....
37024	----	Lifting Presser Bar Spring, use 37408...
37329	----	" " Foot (single) use 37422..
878D	----	Oscillating Rock Shaft Hinge Pin Oil Hole Stop Screw.....

OBSOLETE PARTS

No.	Plate	Name
12459	----	Oscillating Rock Shaft Hinge Pin Oil Hole Stop Screw Washer (leather) ...
2049	6145	Oscillating Shaft Crank Pin, use 3093...
229D	6167	" " " Slide Block Cap Screw, use 226J.....
33941	----	Shuttle Bobbin Case for 33942.....
33942	----	Shuttle Bobbin Case complete for 37337, Nos. 591F, 592E, 2523, 2975, 7553, 15141, 15278 and 33941.....
12393	----	Shuttle Body for 37337.....
15278	----	" Tension Spring for 33942.....
37337	----	" 1 11/16 in. diam., Nos. 2996, 12393 and 33942, use 37855.....
910C	6150	Thread Retainer Set Screw, use 624C.....

SINGER Needles should be used
in SINGER Machines
These Needles and their Containers
are marked with the
Company's Trade Mark "SIMANCO.**" 1

Needles in Containers marked
"FOR SINGER MACHINES"
are NOT SINGER made needles. 2

NUMERICAL LIST OF PARTS

No.	Plate	Name
35D	6150	Bobbin Winder Stop Latch Hinge Screw, for 27847.....
76D	6151	Lifting Lever Connecting Rod Joint Hinge Screw, for 37392 and 37393.....
77J	6133	Hemmer Hinge Screw, for 36259.....
79C	6143	Arm Top Cover Hinge Screw.....
94D	6139	Edge Guide Slide Lever Hinge Screw, for 36291.....
144D	6143	Arm Shaft Screw.....
145E	6109	Shuttle Race Screw.....
155C	6112	Needle Bar Connecting Stud Set Screw, for 37332.....
165D	6145	Feed Regulator Lever Cap Screw.....
178E	6103	Bell Crank Bracket Screw, for 37392 and 37393.....
178F	6103	Feed Bar Guide Bracket Cap Screw.....
178F	6103	" " Socket Joint Cap Screw.....
190J	6145	Binder Ribbon Tension Screw, for 36234 and 121477.....
190J	6145	Binder Screw, for 36237, 36242, 36245, 36248, 36252, 36256, 36270, 36370, 36407, 36410, 36412, 121472, 121474, 121554 and 121557.....
190J	6145	Corder Screw, for 36279.....
190J	6145	Edge Folder Screw, for 120038.....
190J	6145	" Guide Screw, for 36291.....
190J	6145	Feeding Foot Screw.....
190J	6145	Hemmer Bracket Screw, for 36259.....
190J	6145	Hemmer Screw, for 36263, 36267, 120041 and 121495.....
190J	6145	Lifting Presser Foot Screw.....
190J	6145	Piping Attachment Screw, for 121561.....
190J	6145	Tension Releasing Lever Connection Extension Screw.....
197J	6127	Binder Adjusting Screw, for 36370.....
207J	6159	" " " " 121484.....
207F	6159	Edge Guide Slide Cap (left) Screw, for 36291.....
207F	6159	Edge Guide Slide Cap (right) Screw (large) for 36291.....
212D	6103	Feed Bar Bell Crank Cap Screw.....
212D	6103	" " " " Slide Block Cap Screw for 37348.....
212D	6103	Lifting Presser Bar Connecting Link Cap Screw.....
217J	6131	Braid Guide Screw, for 36273.....
219F	6143	Cord Guide Arm Adjusting Plate Screw, for 36279.....
219F	6143	Cord Guide Screw, for 36279.....

NUMERICAL LIST OF PARTS

No.	Plate	Name
219F	6143	Face Plate Screw.....
220J	6151	Binder Adjusting Screw,for 36237,36242, 36407,36410,36412 and 121474.....
220J	6151	Binder Folder Screw,for 36234.....
220J	6151	Edge Guide Leveling Screw,for 36291.....
220J	6151	Hemmer Adjusting Screw,for 36263.....
226J	6148	Binder Adjusting Screw,for 121557.....
226J	6148	Edge Folder Adjusting Screw,for 120038..
226J	6148	Hemmer Adjusting Screw,for 120041.....
226J	6148	Oscillating Shaft Crank Slide Block Cap Screw,for 19449.....
228J	6159	Binder Screw,for 121484.....
229J	6187	Needle Plate Needle Guard Screw,for 37399 and 37400.....
229D	6187	Oscillating Shaft Crank Slide Block Cap Screw,obsolete,use 226J.....
230D	6136	Hemmer Adjusting Screw,for 36267.....
230H	6136	Lifting Presser Foot Guide Stud Set Screw,for 36283.....
233J	6123	Binder Adjusting Screw,for 36245,36248, 36252,36256,36270 and 121472.....
233J	6123	Edge Guide Slide Cap (right) Screw (small) for 36291.....
233J	6123	Needle Bar Thread Guard Screw.....
236J	6161	Piping Attachment Adjusting Screw,for 121561.....
284J	6145	Guide Thumb Screw,for 25873 and 28658...
330D	6145	Feed Regulator Lever Clamp Screw,for 37319.....
330D	6145	Feed Regulator Lever Segment Screw.....
356C	6151	Rock Shaft Knee Arm Hub Set Screw, for 2766.....
356C	6151	Rock Shaft Knee Plate Set Screw,for 2767
356C	6151	" " Lifting Bracket Hook Set Screw,for 6337.....
356C	6151	Rock Shaft Lifting Bracket Set Screw,for 6337.....
356C	6151	Rock Shaft Stop Dog Set Screw,for 2770..
391J	6148	Shuttle Bobbin Case Position Plate Screw for 37374.....
418E	6151	Bobbin Winder Tension Screw Stud, for 27308.....
430C	6112	Arm Shaft Flanged Bushing (front) Set Screw.....
430C	6112	Thread Take-up Lever Link Hinge Pin Set Screw.....
448C	6150	Thread Take-up Spring Regulator Set Screw.....
448C	6143	Arm Shaft Flanged Bushing (back) Set Screw.....
448C	6143	Balance Wheel Set Screw,for 4370.....
448C	6143	Oscillating Rock Shaft Hinge Pin Set Screw.....

NUMERICAL LIST OF PARTS

No.	Plate	Name
453C	6145	Lifting Lever Pin Set Screw,for 37346...
453C	6145	" " Presser Bar Lifting Bracket Set Screw,for 37328.....
457C	6161	Oscillating Shaft Crank Set Screw,for 37386.....
462C	6161	Shuttle Driver Set Screw,for 37372.....
560J	6133	Hemmer Adjusting Screw,for 36256.....
591F	6148	Shuttle Tension Regulating Screw,for 33942 and 224841.....
592E	6148	Shuttle Bobbin Case Latch Stop Screw,for 33942 and 224841.....
624C	6161	Thread Retainer Set Screw.....
648D	6109	Shuttle Race Back Spring Screw,for 37374
665J	6121	Binder Folder Guide Screw,for 36228...
690E	6112	Thread Take-up Crank Wedge Screw.....
691F	6145	Needle Plate Screw.....
725J	6150	Hemmer (adjusting) Screw,for 121495...
725E	6150	Shuttle Race Slide Spring Screw,for 12432.....
748E	6143	Arm Screw (back).....
766D	6151	Lifting Lever Link Hinge Screw,for 37392 and 37393.....
767J	6161	Binder Adjusting Screw,for 121554.....
775E	6112	Needle Bar Connecting Link Cap Screw...
794E	6112	" " " " Adjusting Screw,for 37331.....
802D	6150	Lifting Lever Hinge Screw,for 37392 and 37393.....
806F	6145	Needle Clamp Screw,for 4303.....
854E	6143	Arm Screw (front).....
856C	6145	Needle Bar Crank and Feed Cam Set Screw, for 37333.....
878D	----	Oscillating Rock Shaft Hinge Pin Oil Hole Stop Screw, obsolete.....
896C	6143	Crank Connecting Rod Cap Screw,for 20197
908C	6143	" " " Hinge Screw.....
910C	6150	Thread Retainer Set Screw, obsolete, use 624C.....
940J	6132	Cord Guide Arm Hinge Screw,for 36279....
988C	6148	Oscillating Shaft Crank Slide Block Screw Stud,for 19449.....
1053D	6109	Shuttle Race Cap Screw,for 37405.....
1057D	6145	Feed Regulator Lever Clamping Screw, for 37318.....
1065C	6145	Needle Bar Crank and Feed Cam Position Screw,for 37333.....
1161J	6147	Needle Plate Thread Guard Screw,for 37381,37382,37383,121481,121486 and 121491.....
1210E	6161	Pressure Regulating Thumb Screw.....
1274C	6161	Tension Screw Stud,for 37404.....
1423J	6160	Binder Plate Screw,for 121489.....

NUMERICAL LIST OF PARTS

No.	Plate	Name
1442J	6158	Binder Folder Screw, for 121477.....
1497C	6103	Feed Bar Bell Crank Bracket Set Screw, for 37379.....
1518J	6148	Oscillating Shaft Crank Slide Block Screw Stud Nut, for 37386.....
1521J	6126	Binder Roller Nut, for 36270.....
1521E	6126	Lifting Lever Connecting Rod Lock Nut, for 37392 and 37393.....
1549J	6133	Hemmer Adjusting Screw Nut, for 36259....
1550H	6137	Lifting Presser Foot Guide Stud Nut, for 36289.....
1560C	6161	Tension Regulating Thumb Nut, for 37404..
1562J	6151	Bobbin Winder Tension Regulating Thumb Nut, for 27308.....
1619J	6143	Crank Connecting Rod Hinge Screw Nut....
1620J	6150	Bobbin Winder Frame Hinge Screw Nut, for 27647.....
1813	6145	Feed Regulator Crank Roller and Stud, for 37317.....
1835	6126	Binder Roller, for 36270.....
1852	6137	Guide Roller, for 28658.....
2049	6145	Feed Regulator Crank Pin.....
2049	6145	Oscillating Shaft Crank Pin, obsolete, use 3093.....
2049	6145	Shuttle Driver Pin.....
2102	3471	Bobbin Winder Tension Disc, for 225482...
2102	3471	Tension Disc, for 37404.....
2103	6161	" Spring, for 37404.....
2106	6151	Bobbin Winder Tension Thread Guide, for 27308.....
2362	6139	Edge Guide Slide Cap (left) Steady Pin, for 26803.....
2455	6151	Bobbin Winder Tension Disc, for 27308....
2523	6148	Shuttle Bobbin Case Position Finger Riv- et, for 33942 and 224840.....
2531	6109	Shuttle Race Back, for 37374.....
2532	6109	" " Position Pin, for 37374
2533	6109	" " Spring, for 37374.....
2763	22161	Rock Shaft, for 4880 and 12250.....
2765	22161	" " Knee Arm, for 2768.....
2766	22161	" " Hub with 356C, for 2768.....
2767	22161	Rock Shaft Knee Plate with 356C, for 2768
2768	-----	Rock Shaft Knee Arm complete, for 12250, Nos. 2765 to 2767.....
2770	22161	Rock Shaft Stop Dog with 356C, for 4880 and 12250.....
2778	22161	Rock Shaft Lifting Bracket Hook, for 12250.....
2818	6133	Hemmer Friction Washer, for 36259.....
2827	6143	Face Plate Thread Guard (lower) with 8505, for 37306.....

NUMERICAL LIST OF PARTS

No.	Plate	Name
2973	6148	Shuttle Bobbin Case Latch Lever, for 15141.....
2974	6148	Shuttle Bobbin Case Latch Lever Fulcrum Pin, for 15141.....
2975	6148	Shuttle Bobbin Case Latch Spring, for 33942 and 224841.....
2996	6148	Shuttle Bobbin, for 37337 and 37855.....
3093	6161	Oscillating Shaft Crank Pin.....
3094	6112	Thread Take-up Crank Wedge.....
3146	6161	Guide Thumb Screw Washer, for 25873.....
4302	6147	Needle Bar Thread Guard.....
4303	6147	" Clamp with 808F.....
4307	6162	Shuttle Race Slide Spring, for 12432....
4370	6154	Balance Wheel, heavy rim, 2 3/4 in. pulley with two 448C.....
4430	6143	Arm Top Cover Friction Washer.....
4727	6151	Lifting Lever Pin, for 37392 and 37393...
4784	6161	Oscillating Rock Shaft Oil Pad, for 24105
4879	6151	Chain Connecting Link, for 4885.....
4880	22161	Rock Shaft complete for 37392, Nos. 2768, 2770, 7125, 12243 and two each 6337 and 12242.....
4881	6169	Treadle, for 4885.....
4882	6166	" Shaft, for 4885.....
4883	6166	" Spring, for 4885.....
4884	6169	" Stand, for 4885.....
4885	6169	Treadle complete for 37392, Nos. 4879, 4881 to 4884 and two wood screws 1 in. No. 16.....
5598	6166	Bell Crank, for 56848.....
5598	6166	Bell Crank complete for 37392 and 37393, Nos. 5735 and 56848.....
5599	6166	Bell Crank Bracket, for 56848.....
5601	6151	" " Hinge Pin, for 56848.....
5670	----	Chain, length 26 in. to 35 in. with 56864 and 56865, for 37392.....
5681	6162	Needle Bar.....
5735	6166	Bell Crank Spring, for 5598.....
5806	6132	Cord Guide Position Pin, for 36275.....
6337	22161	Rock Shaft Lifting Bracket with two 356C for 4880 and 12250.....
7071	6121	Binder Adjusting Screw Washer, for 36370.
7071	6121	" Ribbon Tension Screw Washer, for 36234 and 121477.....
7071	6121	Binder Screw Washer, for 36237, 36242, 36245, 36248, 36252, 36256, 36270, 36370, 36407, 36410, 36412, 121472, 121474, 121554 and 121557.....
7071	6121	Corder Screw Washer, for 36279.....
7071	6121	Cord Guide Arm Adjusting Plate Screw Washer, for 36279.....
7071	6121	Edge Folder Screw Washer, for 120038....

NUMERICAL LIST OF PARTS

No.	Plate	Name
7071	6121	Hemmer Bracket Screw Washer, for 36259...
7071	6121	" Screw Washer, for 36263, 36267, 120041 and 121495.....
7071	6121	Piping Attachment Screw Washer, for 121561.....
7071	6121	Tension Releasing Lever Connection Extension Screw Washer.....
7125	22161	Rock Shaft Lifting Bracket Hook, for 4880
7299	6182	Feed Bar.....
7539	22161	Rock Shaft Hanger with two wood screws 1 in. No. 10, for 12250.....
*7553	6148	Shuttle Bobbin Case Position Finger, for 33942 and 224840.....
7806	6151	Binder Adjusting Screw Washer, for 36237, 36242, 36252, 36256, 36270, 36407, 36410, 36412, 121472, 121474 and 121554.....
7806	6151	Binder Folder Screw Washer, for 36234....
7806	6151	Hemmer Adjusting Screw Washer, for 36263.
8068	6136	" " " " " 36267.
8285	6161	Tension Releasing Lever Hinge Pin.....
8505	6143	Face Plate Thread Guard (lower) Rivet, for 2827.....
8505	6143	Face Plate Thread Guard (upper) Rivet, for 37307.....
8511	6150	Thread Take-up Spring (music wire) for 37404.....
8582	6143	Arm Dowel Pin.....
8879	6143	" Top Cover Spool Pin and Thread Eyelet Washer (cloth).....
8909	6120	Wrench, for 1518 (Accessories).....
10141	6151	Bobbin Winder Tension Spring, for 27308..
11119	6143	Arm Oil Tube 15783 with 52045, for oiling Thread Take-up Lever.....
11204	6112	Thread Take-up Lever Link Hinge Pin....
11241	22395	Bobbin Winder Spool Washer (cloth) for 27308.....
12149	6161	Tension Thread Guard.....
12152	6139	Edge Guide Slide Spring Cover Rivet, for 36775.....
12166	6112	Thread Take-up Lever Hinge Pin, for 37345
12242	22161	Rock Shaft Hanger with two wood screws 1 in. No. 10, for 4880.....
12243	22161	Rock Shaft Lifting Bracket Hook, for 4880
12250	22161	Rock Shaft complete for 37393, Nos. 2763, 2768, 2778, 6337 and two each 2770 and 7539.....
12357	6144	Arm Shaft Flanged Bushing (back).....
12361	6150	Machine Hinge Connection, for 44140 (Accessories).....
12388	6162	Oscillating Rock Shaft Hinge Pin, for 24105.....
12389	6189	Oscillating Shaft.....

NUMERICAL LIST OF PARTS

No.	Plate	Name
12393	----	Shuttle Body, for 37337, obsolete.....
12405	6150	Machine Rest (felt) Accessories.....
12415	6144	Lifting Lever Connecting Rod, for 37392 and 37393.....
12416	6151	Lifting Lever Connecting Rod Joint, for 37392 and 37393.....
12424	6148	Oscillating Shaft Crank Slide Block Cap Screw Washer, for 19449.....
12431	----	Shuttle Race Slide, for 12432.....
12432	6182	Shuttle Race Slide complete, Nos. 4307, 12431 and two 725E.....
12454	6143	Arm Oil Tube with 132690, for oiling Thread Take-up Lever Link.....
12459	----	Oscillating Rock Shaft Hinge Pin Oil Hole Stop Screw Washer (leather) obsolete.....
15072	6150	Bobbin Winder Bobbin Position Pin, for 27538.....
15140	6148	Shuttle Bobbin Case Latch, for 15141.....
15141	----	" " " Hinge, Nos. 2973, 2974 and 15140, for 33942 and 224841....
15170	6103	Feed Bar Bell Crank Slide Block, for 37348.....
15278	----	Shuttle Tension Spring, for 33942, obsolete.....
*15404	----	Trade Mark, for 37363.....
15405	----	" " Rivet, for 37363.....
15783	----	Arm Oil Tube, for 11119.....
17542	6145	Lifting Presser Bar Lifter Hinge Pin....
18055	6145	Feeding Foot Hinge Pin, for 37354, 37358, 37419 and 37421.....
18055	6145	Lifting Presser Foot Hinge Pin, for 37416
19221	6120	Wrench, for 1619 (Accessories).....
19448	6148	Oscillating Shaft Crank Slide Block, for 19449.....
19449	----	Oscillating Shaft Crank Slide Block, complete for 37386, Nos. 226J, 988C, 12424 and 19448.....
20021	----	Drip Pan with four 1 in. wire nails, obsolete, use 44212.....
20197	6144	Crank Connecting Rod with two 896C.....
22372	6103	Feed Bar Guide Bracket Slide Block, for 37367.....
24078	6150	Thread Guard (side of arm).....
24104	6162	Oscillating Rock Shaft, for 24105.....
24105	----	Oscillating Rock Shaft complete, Nos. 4784 12388 and 24104.....
24143	6181	Tension Releasing Lever Spring.....
25734	6158	Binder Ribbon Tension complete for 121477, Nos. 26617, 26618 and seven 26486.....
25873	6166	Guide (combination).....

No.	Plate	Name
26026	6120	Screw Driver (machine) Accessories.....
26485	6120	" " (shuttle tension) Accessories.....
26486	6158	Binder Ribbon Tension Pin (straight) for 25734.....
26614	6121	Binder Ribbon Tension Pin (bent) for 36231.....
26615	6121	Binder Ribbon Tension Pin (straight) for 36231.....
26617	6158	Binder Ribbon Tension Pin (bent) for 25734.....
26618	6158	Binder Ribbon Tension Plate, for 25734....
26603	6139	Edge Guide Bed with 2362, for 36291.....
26805	6139	" " Slide Cap (left) for 36291....
26806	6139	" " " " (right) for 36291..
26807	6139	" " " " Lever, for 36291.....
26808	6139	" " " " Spring, for 36291.....
26809	6139	" " " " Cover, for 36775.
27302	22395	Bobbin Winder Frame, for 27647.....
27303	6161	" " " " Spring, for 27647....
27308	22395	" " " " Spool Pin, for 27308.....
27307	22395	" " " " Stand, for 27308.....
27308	22395	Bobbin Winder Spool Stand complete, for 27544, Nos. 418E, 1562J, 2106, 10141, 11241, 27306, 27307 and two each 2455 and wood screws 1 in. No. 10.....
27312	22395	Bobbin Winder Stop Latch, for 27647.....
27538	22395	" " " " Spindle 27849 with 15072, 27850 and 41828, for 27647.....
27540	22395	Bobbin Winder Base, for 27647.....
27541	22395	" " " " Pulley, for 27647.....
27544	-----	Bobbin Winder (swinging automatic, right hand) complete for 2996, for stand, Nos. 27308 and 27647.....
27647	22395	Bobbin Winder for 27544, Nos. 35D, 1620J, 27302, 27303, 27312, 27538, 27540, 27541, 50358D and two wood screws 1 in. No. 7
*27849	-----	Bobbin Winder Spindle, for 27538.....
*27850	6150	" " " " Collar, for 27538..
28658	6137	Guide (roller) with 1852, for 36289.....
29505	6144	Arm Top Cover, for 29506.....
29506	6144	Arm Top Cover complete, Nos. 29505, 29507 and 29601.....
29507	6143	Arm Top Cover Spool Pin and Thread Eyelet, for 29506.....
29601	6143	Arm Top Cover Spool Pin and Thread Eyelet Washer (steel) for 29506.....
32572	6161	Tension Releasing Disc, for 37404.....
32574	6161	" " " " Pin, for 37404.....
33941	-----	Shuttle Bobbin Case, for 33942, obsolete.
33942	-----	Shuttle Bobbin Case complete for 37337, Nos. 591F, 592E, 2523, 2975, 7553, 15141, 15278 and 33941, obsolete.....

No.	Plate	Name
36228	6121	Binder Folder with 665J and 36229, for 36234.....
36229	6121	Binder Folder Guide, for 36228.....
36230	6121	" " Ribbon Tension Plate, for 36231....
36231	6121	Binder Ribbon Tension complete for 36234 Nos. 26614, 36230 and six 26615.....
36232	6128	Feeding Foot, for 36234, 36410, 121472, 121474, 121484, 121489, 121495 and 121557.....
36233	6128	Lifting Presser Foot, for 36234, 36410, 121472, 121474, 121484, 121489 and 121495.....
36234	----	Binder (English) complete, Nos. 220J, 7806, 36228, 36231 to 36233 and two each 190J and 7071.....
36235	----	Binder, for 36237.....
36236	----	" Shank, for 36237, 36407, 36412 and 121474.....
36238	----	Hemmer Shank, for 36283.....
36237	6122	Binder on Shank complete, for mattress work, Nos. 36235, 36236 and two each 220J and 7806.....
36238	6122	Feeding Foot, for 36237 and 36242.....
36239	6122	Lifting Presser Foot, for 36237 and 36242
36240	----	Binder, for 36242.....
36241	----	" Shank, for 36242.....
36242	6122	Binder on Shank complete, for furniture slip covers, Nos. 36240, 36241 and two each 220J and 7806.....
36243	----	Binder, for 36245.....
36244	----	" Shank, for 36245 and 36248.....
36245	6123	Binder on Shank complete, for enameled binding, for chair bottoms, seat curtains or other similar work, Nos. 36243, 36244 and two 233J.....
36246	6123	Lifting Presser Foot, for 36245.....
36247	----	Binder, for 36248.....
36248	6124	Binder on Shank complete, for bias binding, for turning under both edges of binding, for general work, Nos. 36244, 36247 and two 233J.....
36249	6124	Lifting Presser Foot, for 36248, 36256, 36259 and 36407.....
36250	----	Binder, for 36252.....
36251	----	" Shank, for 36252.....
36252	6125	Binder on Shank complete, for bias binding to turn under the top edge only, for suspender ends and other similar work, Nos. 233J, 7806, 36250 and 36251..
36253	6125	Lifting Presser Foot, for 36252, 36291 and 121554.....
36254	----	Binder, for 36258.....

NUMERICAL LIST OF PARTS

No.	Plate	Name
36255	----	Binder Shank, for 36256 and 36410.....
36256	6124	Binder on Shank complete, for binding with braid, for general work, Nos. 233J * 7806, 36254 and 36255.....
36257	6133	Hemmer, for 36259.....
36258	6133	" Bracket, for 36259.....
36259	6133	Hemmer (suspended) complete, for flags, Nos. 77J, 560J, 1549J, 2818, 36257 and 36258.....
36260	6131	Feeding Foot, for cording, for 36261.....
36261	6131	Lifting Presser Foot, for cording, for 36260.....
36262	----	Hemmer, for 36263.....
36263	6134	Hemmer on Shank complete, for canvas enameled cloth, thin leather, etc., Nos. 36236, 36262 and two each 220J and 7806.....
36264	6134	Lifting Presser Foot, for 36263 and 36267
36265	6135	Hemmer, for 36267.....
36266	6136	" Shank, for 36267.....
36267	----	Hemmer on Shank complete, for 2 in. to 4 in. hem, for sheets, Nos. 36265, 36266 and two each 230D and 8068.....
36268	----	Binder, for 36270.....
36269	----	" Shank, for 36270.....
36270	6126	Binder on Shank complete, for light leather or oil cloth binding, for leather, Nos. 1521J, 1835, 36268, 36269 and two each 233J and 7806.....
36271	6126	Feeding Foot, for 36270.....
36272	6126	Lifting Presser Foot, for 36270.....
36273	6131	Braid Guide (front of arm) for braiding.
36274	6131	Feeding Foot, for braiding, for 37330.....
36275	6132	Cord Guide with 5806, for 36279.....
36276	6132	" " Arm, for 36279.....
36277	6132	" " Adjusting Plate, for 36279
36278	6132	" " Bed, for 36279.....
36279	6132	Corder complete, for buggy cushions, Nos. 940J, 7071, 36275 to 36278 and two 219F.....
36280	6132	Feeding Foot, for cording, for 36279, 121496 and 121561.....
36281	6132	Lifting Presser Foot for 36279 and 121561.....
36282	6137	Feeding Foot, for 36289.....
36283	6137	Lifting Presser Foot with 230H, for 36289
36284	6137	" " Guide with 36285, for 36289.....
36285	6137	Lifting Presser Foot Guide Bushing, for 36284.....
36286	6137	Lifting Presser Foot Guide Spring, for 36289.....

NUMERICAL LIST OF PARTS

No.	Plate	Name
36287	6137	Lifting Presser Foot Guide Spring Washer - for 36289.....
36288	6137	Lifting Presser Foot Guide Stud, for 36289.....
36289	6137	Lifting Presser Foot with Spring Guide complete, for inserting cord or reed on leather, for harness work, Nos. 1550H, 36283, 36284 and 36286 to 36288
36291	6139	Edge Guide (roller) complete, Nos. 94D, 233J, 26803, 26805 to 26808, 36775, two 207F and four 220J.....
36368	6127	Binder, for 36370.....
36369	6127	" Shank, for 36370.....
36370	----	Binder on Shank complete, for binding comfortables, Nos. 36368, 36369 and two each 197J and 7071.....
36371	6127	Feeding Foot, for 36370.....
36372	6127	Lifting Presser Foot, for 36370.....
36406	----	Binder, for 36407.....
36407	6130	Binder on Shank complete, for binding two pieces of leather with thin leather binding, Nos. 36236, 36406 and two each 220J and 7806.....
36409	----	Binder, for 36410.....
36410	6128	Binder on Shank complete, for binding ticket holders with imitation leather binding, Nos. 220J, 7806, 36255 and 36409.....
36411	----	Binder, for 36412.....
36412	6163	Binder on Shank complete, for general work, for first line of stitching, for binding with tape, lower part of binding to extend under for second line of stitching, Nos. 36236, 36411 and two each 220J and 7806.....
36775	6139	Edge Guide Slide with 26809, 51809 and two 12152, for 36291.....
37023	6162	Lifting Presser Bar (hollow).....
37024	----	" " Spring, obsolete, use 37408.....
37025	6145	Lifting Presser Bar Spring Pin.....
37303	6144	Arm Shaft Flanged Bushing (front).....
37304	----	Bed.....
37305	----	Face Plate with 37307, for 37306.....
37306	6144	Face Plate complete, Nos. 2827 and 37305..
37307	6143	" " Thread Guard (upper) with two 8505, for 37305.....
37310	6103	Feed Bar Bell Crank Cap Screw Washer....
37310	6103	Lifting Presser Bar Connecting Link Cap Screw Washer.....
37314	6103	Feed Bar Socket Joint.....
37315	6103	" " " Cap.....

No.	Plate	Name
37317	6144	Feed Regulator Crank with 1813.....
37318	6144	" " Lever with 1057D, for 37319.....
37319	----	Feed Regulator Lever 37318 with 330D and 37320.....
37320	6145	Feed Regulator Lever Clamp,for 37319....
37322	6145	" " " Shaft.....
37324	----	Feeding Foot Shank,for 37354 and 37419..
37326	6123	" " for 36245,36248,36252,36256 36259,36263,36267,36291,36407,37330 and 121554.....
37327	6145	Lifting Presser Bar Connecting Link....
37328	6144	" " " Lifting Bracket with 453C.....
37329	----	Lifting Presser Foot (single) obsolete, use 37422.....
37330	6131	Lifting Presser Foot (double) for braiding, for 36274 and 37326.....
37331	6112	Needle Bar Connecting Link with 794E....
37332	6112	" " Stud with 155C,for 37348.....
37333	6162	Needle Bar Crank and Feed Cam with 858C and 1065C.....
37337	----	Shuttle, 1 11/16 in.diam.,Nos.2996,12393 and 33942,obsolete,use 37855.....
37343	6112	Thread Take-up Lever,for 37345.....
37344	6112	" " Link,for 37345.....
37345	----	Thread Take-up Lever complete,Nos.12166, 37343 and 37344.....
37346	6169	Lifting Lever with 453C,for 37392 and 37393.....
37348	----	Needle Bar Connecting Stud 37332 with 212D and 15170.....
37351	6150	Thread Take-up Spring Regulator,for 37404.....
37353	----	Feeding Foot Plate,for 37354.....
37354	6168	Feeding Foot (hinged) complete,for thin material,Nos.18055,37324 and 37353..
37356	----	Feeding Foot Plate,for 37358,obsolete...
37357	----	" " Shank,for 37358 and 37421..
37357	----	Lifting Presser Foot Shank,for 37416....
37358	----	Feeding Foot (hinged) complete,for automobile work,Nos.18055,37356 and 37357,obsolete,use 37421.....
37360	----	Shuttle Race Body,for 37405.....
37361	6109	" " Cap,for 37405.....
37363	----	Arm with 15404 and two 15405.....
37364	6103	Feed Bar Guide Bracket.....
37365	----	" " " Cap,for 37366.....
37366	6103	" " " " " 37365 with 37367.....
37367	----	Feed Bar Guide Bracket Slide Block 22372 with 37368,for 37366.....

No.	Plate	Name
37368	6103	Feed Bar Guide Bracket Slide Block Stud, for 37367.....
37369	6144	Feed Forked Connection.....
37370	6162	" Regulator Lever Segment.....
37371	----	Shuttle Driver,for 37372.....
37372	6148	" " 37371 with two 462C.....
37373	6162	" Bobbin Case Position Plate,for 37374.....
37374	6109	Shuttle Race complete,Nos.648D,2531,2533 37373,37405 and two each 391J and 2532.....
37375	6162	Tension Releasing Lever.....
37377	6154	Arm Shaft.....
37378	6103	Feed Bar Bell Crank.....
37379	6103	" " " Bracket with 1497C..
37380	6145	Lifting Presser Bar Lifter.....
37381	6147	Needle Plate 37423 with 37384 and two 1161J.....
37382	6147	Needle Plate 37424 with 37384 and two 1161J.....
37383	----	Needle Plate,small needle hole, with 37384 and two 1161J.....
37384	6147	Needle Plate Thread Guard,for 37381, 37382,37383,121481,121486 and 121491
37385	----	Oscillating Shaft Crank,for 37386.....
37386	6148	Oscillating Shaft Crank complete,Nos. 457C,1518J,19449 and 37385.....
37387	6162	Tension Releasing Lever Connection....
37388	6162	" " " Extension
37389	6112	Thread Take-up Crank.....
37390	6151	Lifting Lever Link,for 37392 and 37393..
37392	----	Foot Lifter complete,Nos.76D,766D,802D, 1521E,4727,4880,4885,5598,5670,12415 12416,37346,37390 and two 178E.....
37393	----	Knee Lifter complete (power table or stand) Nos.76D,766D,802D,1521E,4727, 5598,12250,12415,12416,37346,37390 and two 178E.....
37397	6168	Feeding Foot,for 37398.....
37398	6168	Lifting Presser Foot,for 37397.....
37399	6167	Needle Plate,large needle hole,with 37401 and two 229J.....
37400	----	Needle Plate,small needle hole,with 37401 and two 229J.....
37401	6167	Needle Plate Needle Guard,for 37399 and 37400.....
37404	----	Tension complete,Nos.1274C,1560C,2103, 8511,32572,32574,37351 and two 2102.
37405	----	Shuttle Race Body 37360 with 37361 and two 1053D,for 37374.....
37408	6162	Lifting Presser Bar Spring.....
37415	----	" " Foot Plate,for 37416....

No.	Plate	Name
37418	6168	Lifting Presser Foot (hinged) complete, for stitching brims of straw hats together, Nos. 18055, 37357 and 37415..
37418	----	Feeding Foot Plate, for 37419.....
37419	6168	Feeding Foot (hinged) complete for 37422 Nos. 18055, 37324 and 37418.....
37420	----	Feeding Foot Plate, for 37421.....
37421	6163	Feeding Foot, (hinged) complete for 36412 and 37422, Nos. 18055, 37357 and 37420.
37422	6163	Lifting Presser Foot for 36412, 37419 and 37421.....
37423	6147	Needle Plate (large needle hole) for 37381.....
37424	6147	Needle Plate (medium needle hole) for 37382.....
37854	6148	Shuttle Body, for 37855.....
37855	6148	" 1 11/16 in. diam., Nos. 2998, 37854 and 224841.....
41400	6120	Machine Rest Pin (wood) 3 1/8 in. long (Accessories).....
41828	6150	Bobbin Winder Spindle Collar Pin, for 27538.....
44139	6150	Machine Hinge Plate, for 44140 (Accessories).....
44140	----	Machine Hinge complete, Nos. 12361, 44139 and merlized wood screw 1 1/4 in. No. 14 (Accessories).....
44212	6154	Drip Pan with four 1 in. wire nails.....
50004B	6158	Binder Screw, for 121477.....
50183J	6180	" Adjusting Screw, for 121489.....
50356D	6150	Bobbin Winder Frame Hinge Screw, for 27847.....
51224J	6145	Feed Regulator Lever Clamp Thumb Screw..
51809	6139	Edge Guide Slide Roller and Stud, for 36775.....
52045	6143	Arm Oil Tube Packing (wick) for 11119...
52454	6150	Thread Retainer.....
56848	----	Bell Crank 5598 with 5599 and 5801, for 5598.....
56864	6151	Chain Hook (large) for 5670.....
56865	6151	" " (small) for 5670.....
120036	----	Edge Folder, for 120038.....
120037	----	" " Shank, for 120038.....
120038	6165	Edge Folder on Shank complete, for 120041 Nos. 120036, 120037 and two 228J.....
120039	----	Hemmer, for 120041.....
120040	----	" Shank, for 120041.....
120041	6185	Hemmer on Shank complete, for canvas, Nos. 120039, 120040 and two 228J.....
120342	6120	Oiler (copper plated) with 120343 (Accessories).....
120343	6120	Oiler Spout, 3 1/2 in. long, for 120342 (Accessories).....

No.	Plate	Name
121470	6156	Binder, for 121472.....
121471	6156	" Shank, for 121472.....
121472	6156	Binder (adjustable) on Shank complete, for heavy seams, Nos. 121470, 121471 and two each 233J and 7806.....
121473	6157	Binder, for 121474.....
121474	6157	Binder (adjustable) on Shank complete, for oilcloth, Nos. 36236, 121473 and two each 230J and 7806.....
121475	6158	Binder Folder, for 121477.....
121476	6158	" Plate, for 121477.....
121477	----	Binder (English) complete, for imitation binding of suitcase work, Nos. 1442J, 25734, 121475, 121476, 121479, 121479, 121481 and two each 190J, 7071 and 50004B.....
121478	6157	Feeding Foot, for 121477.....
121479	6157	Lifting Presser Foot, for 121477.....
121480	6157	Needle Plate, for 121481.....
121481	6157	" " 121480 with 37384 and two 1181J, for 121477.....
121482	6159	Binder, for 121484.....
121483	6159	" Plate, for 121484.....
121484	----	Binder (English) complete, for canvas work, Nos. 228J, 36232, 36233, 121482, 121483, 121486 and two 207J.....
121485	6159	Needle Plate, for 121486.....
121486	6159	" " 121485 with 37384 and two 1181J, for 121484.....
121487	6160	Binder (transverse) for 121489.....
121488	6180	" Plate, for 121489.....
121489	----	Binder (transverse) complete, for binding leather shoes, Nos. 1423J, 36232, 36233, 121487, 121488, 121491 and two 50183J.
121490	6160	Needle Plate, for 121491.....
121491	6160	" " 121490 with 37384 and two 1181J, for 121489.....
121492	6156	Hemmer Folder (lower) for 121495.....
121493	6156	" " (upper) for 121495.....
121494	6156	" Shank, for 121495.....
121495	6156	Hemmer (adjustable) on Shank complete, for canvas work, Nos. 121492 to 121494 and four 725J.....
121496	6167	Lifting Presser Foot, for cording, for 36280.....
121552	----	Binder, for 121554.....
121553	----	" Shank, for 121554.....
121554	6164	Binder on Shank complete, for bias cut binding, Nos. 121552, 121553 and two each 767J and 7806.....
121555	----	Binder, for 121557.....
121556	----	" Shank, for 121557.....

NUMERICAL LIST OF PARTS

No.	Plate	Name
121557	6165	Binder on Shank complete, for hat rims, Nos. 121555, 121556 and two 226J.....
121558	6168	Lifting Presser Foot, for 121557.....
121559	----	Piping Attachment, for 121561.....
121560	----	" " Shank, for 121561.....
121561	6165	Piping Attachment on Shank complete, for furniture upholstery, Nos. 121559, 121560 and two 236J.....
132590	6161	Arm Oil Tube Packing (wick) for 12454....
200056E	3471	Bobbin Winder Stop Latch Screw, for 225382.....
200082D	3471	Bobbin Winder Tension Bracket Screw, for 225382.....
200299H	3471	Bobbin Winder Stop Latch Trip Lever Hinge Screw, for 225382.....
200380C	3471	Bobbin Winder Pulley Set Screw, for 202473.....
201499B	3471	Bobbin Winder Tension Stud, for 225461....
201572B	3471	" " " " Thumb Nut, for 225462.....
202277	3471	Bobbin Winder Frame Oil Packing (wick) for 225453.....
202407	3471	Bobbin Winder Tension Spring, for 225462.
202473	6169	" " Pulley with 200380C, for 225382.....
202478	3471	Bobbin Winder Stop Latch Trip Lever, for 225382.....
224840	----	Shuttle Bobbin Case with 2523 and 7553, for 224841.....
224841	6148	Shuttle Bobbin Case complete for 37855, Nos. 591F, 592E, 2975, 15141, 224840 and 224842.....
224842	6148	Shuttle Tension Spring, for 224841.....
225381	22395	Bobbin Winder Spindle, for 225382.....
225382	6169	Bobbin Winder (swinging automatic, right hand) complete for 2996, for power table, Nos. 200056E, 200082D, 200299H, 202473, 202478, 225381, 225433, 225444, 225453 to 225458, 225458, 225462, 228026 and two each 225459 and wood screws 3/4 in. No. 12 R.H.B.....
225433	6169	Bobbin Winder and Tension Bracket Base, for 225382.....
225438	3471	Bobbin Winder Frame Oil Well Cap, for 225453.....
225444	3471	Bobbin Winder Stop Latch, for 225382.....
225453	22395	" " Frame with 202277 and 225438, for 225382.....
225454	3471	Bobbin Winder Frame Hinge Pin, for 225382
225455	3471	" " " Spring, for 225382...
225456	3471	" " " Plunger, for 225382.....

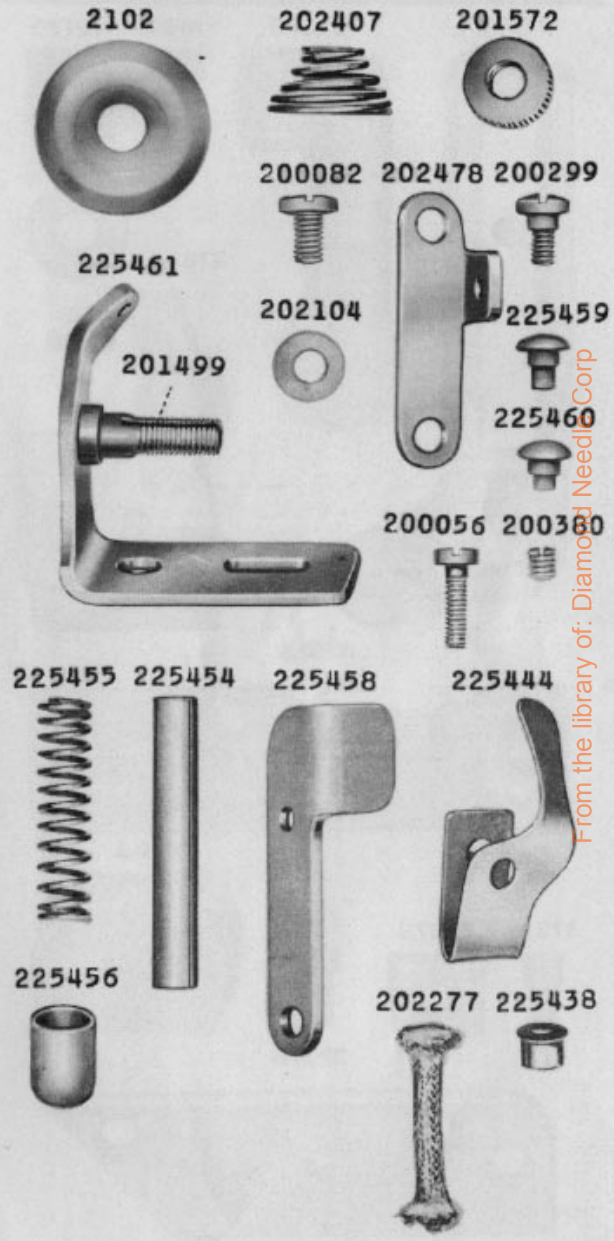
NUMERICAL LIST OF PARTS

No.	Plate	Name
225456	3471	Bobbin Winder Stop Latch Thumb Lever, for 225382.....
225459	3471	Bobbin Winder Stop Latch Thumb Lever Hinge Stud, for 225382.....
225459	3471	Bobbin Winder Stop Latch Thumb Lever Joint Stud, for 225382.....
225461	3471	Bobbin Winder Tension Bracket with 201499B, for 225462.....
225462	----	Bobbin Winder Tension Bracket complete, for 225382, Nos. 201572B, 202407, 225461 and two 2102.....
228026	6161	Bobbin Winder Tension Bracket Screw Washer, for 225382.....

PLATE 3471—FULL SIZE

SINGER Needles should be used
 in SINGER Machines
 These Needles and their Containers
 are marked with the
 Company's Trade Mark "SIMANCO.**" 1

Needles in Containers marked
 "FOR SINGER MACHINES"
 are NOT SINGER made needles. 2



From the library of: Diamond Needle Corp

PLATE 6103—FULL SIZE

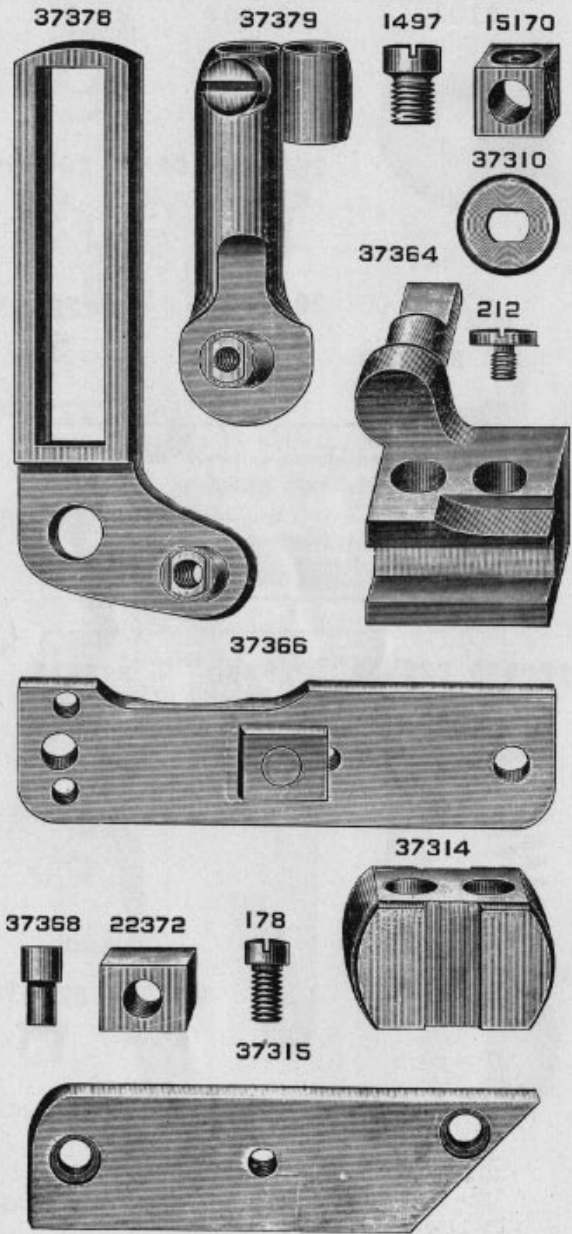
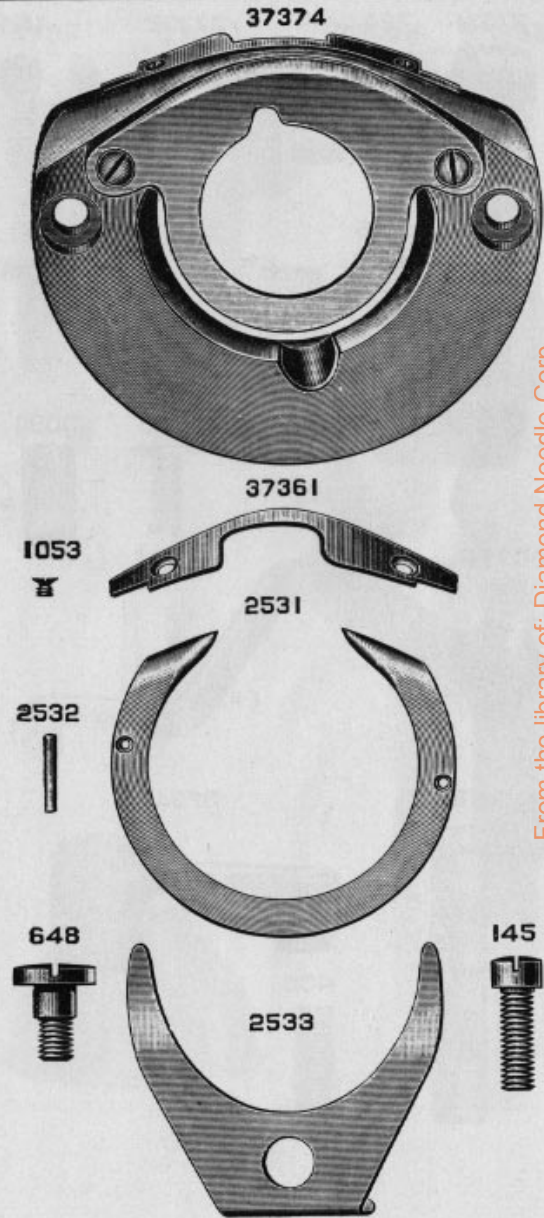


PLATE 6109—FULL SIZE



From the library of: Diamond Needle Corp

8666-4

PLATE 6112—FULL SIZE

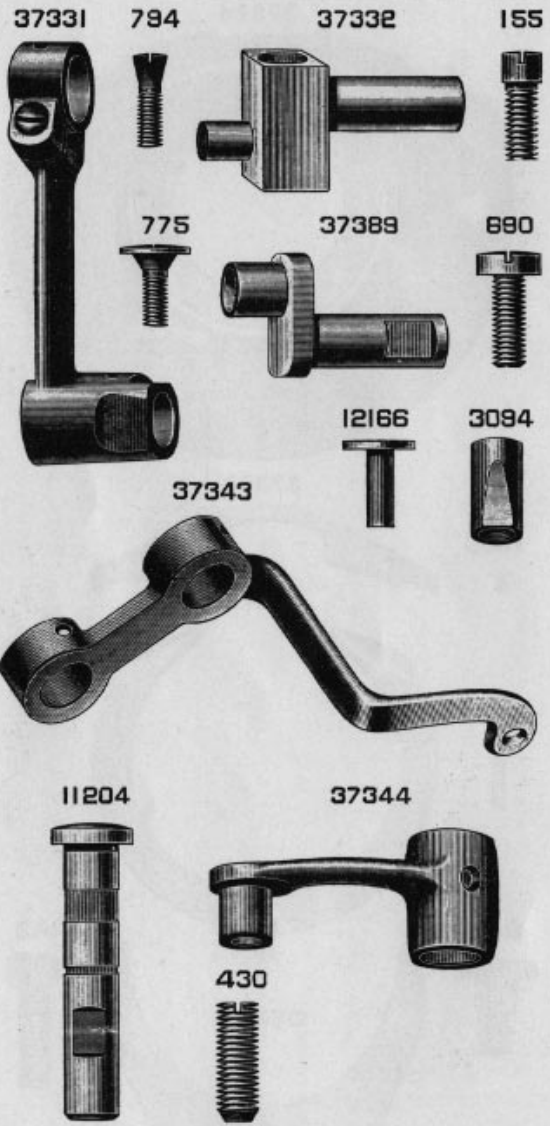
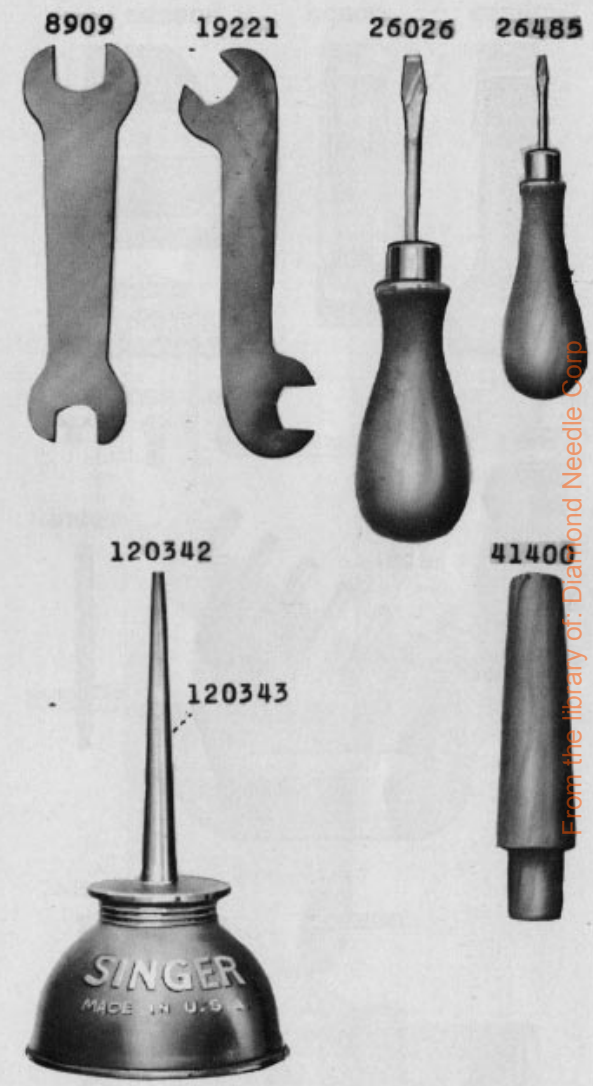


PLATE 6120—ONE-HALF SIZE



From the library of: Diamond Needle Corp

PLATE 6121—FULL SIZE

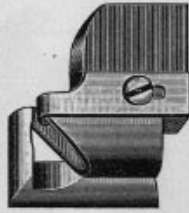
36233



36232



36228



36229



7806



220



665



180



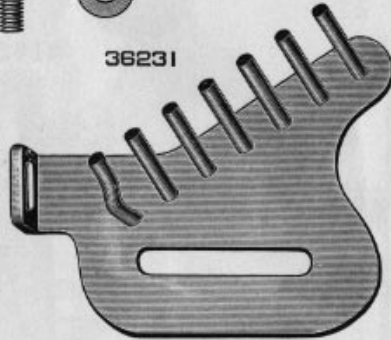
7071



26615



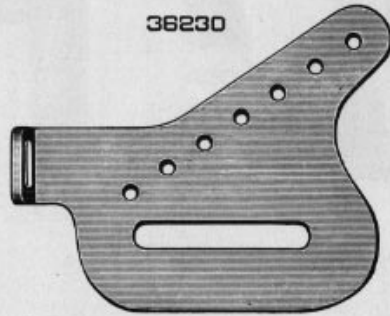
36231



26614



36230



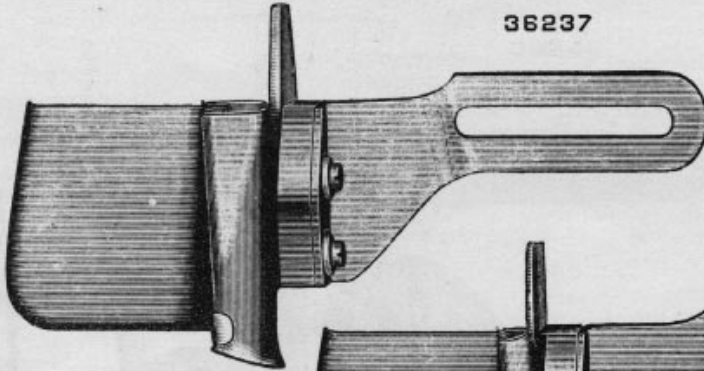
36239



36238



36237



36242

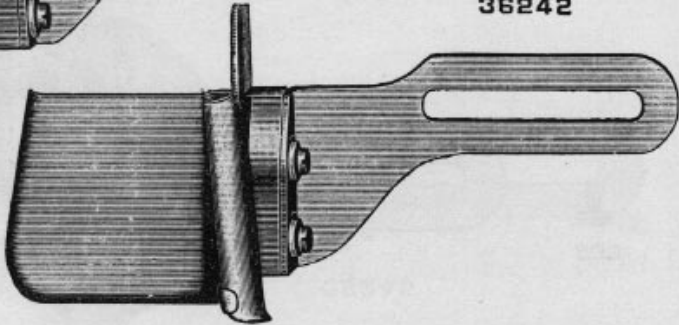
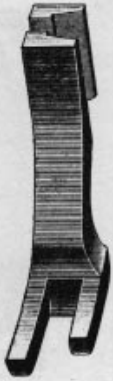


PLATE 6122—FULL SIZE

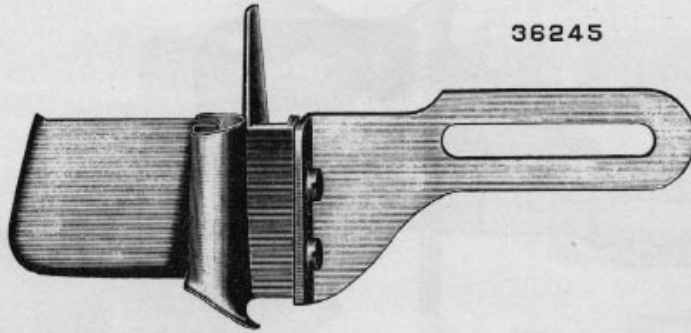
36246



37326



36245

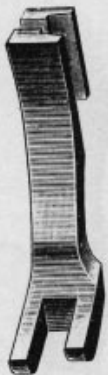


233



PLATE 6123—FULL SIZE

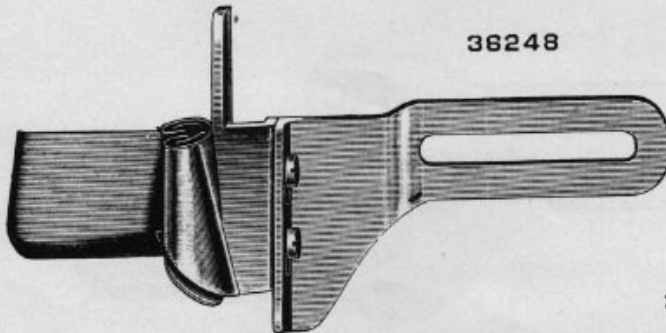
36249



37326



36248



36256

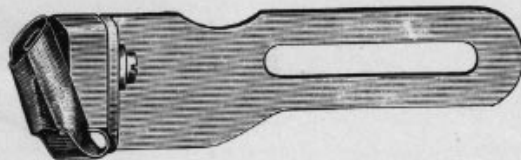
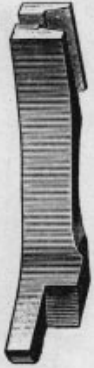


PLATE 6124—FULL SIZE

36253



37326



36252

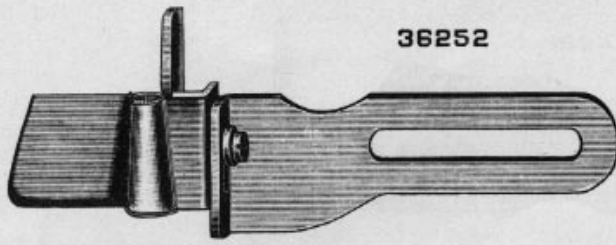
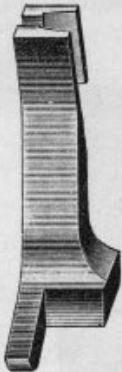


PLATE 6125—FULL SIZE

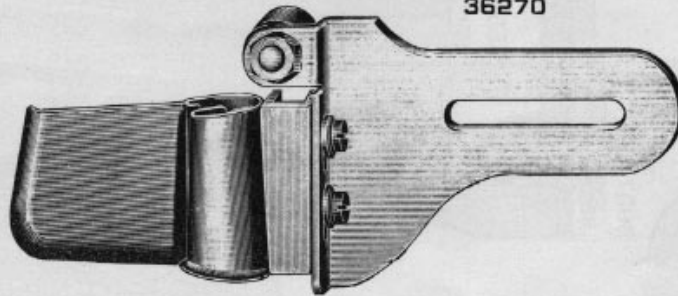
36272



36271



36270



1835

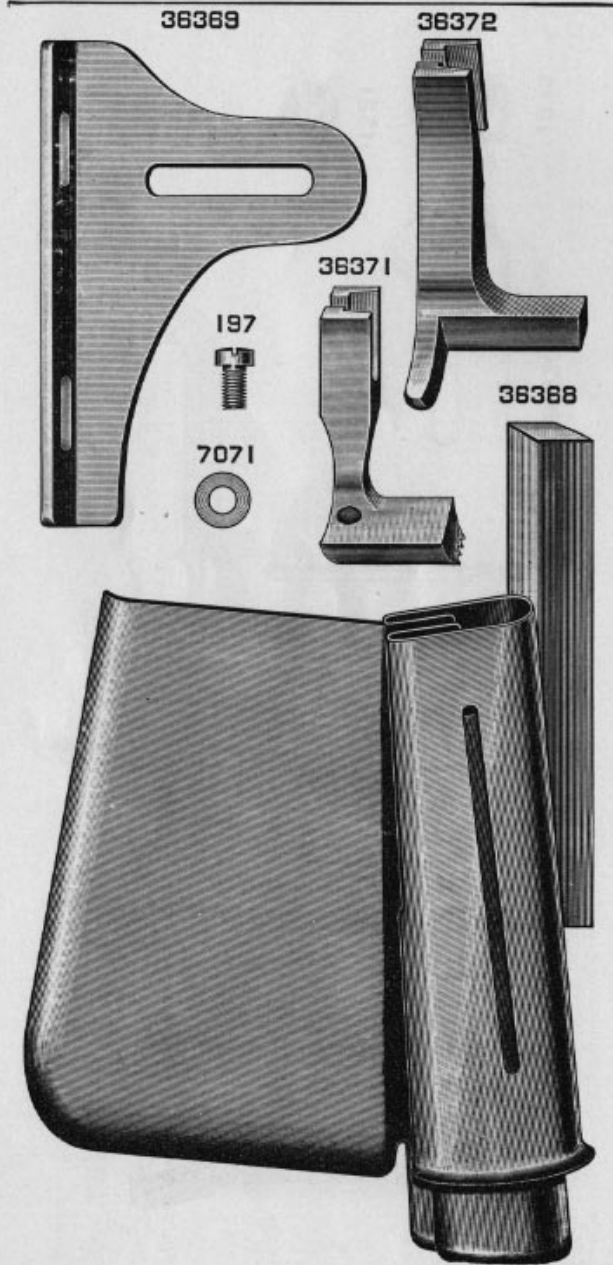


1521

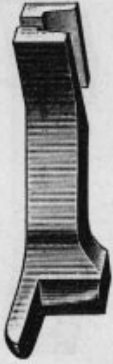


PLATE 6126—FULL SIZE

PLATE 6127—FULL SIZE



36233



36232



36410

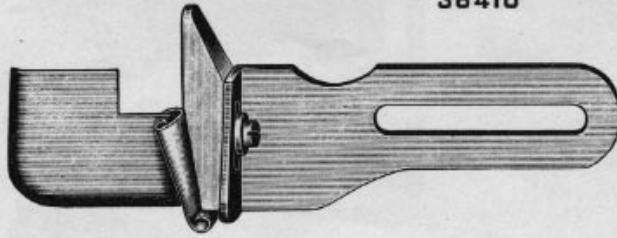


PLATE 6128—FULL SIZE

36249



37328



36407

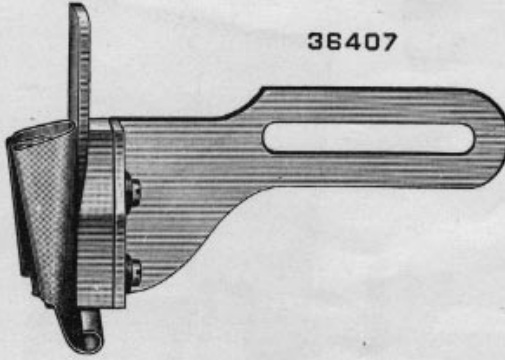
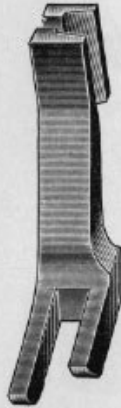


PLATE 6130—FULL SIZE

PLATE 6131—FULL SIZE

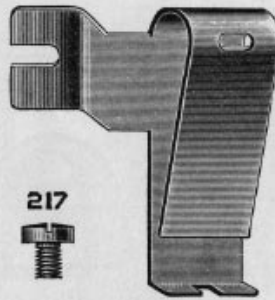
37330



36274



36273



217



36261



36260



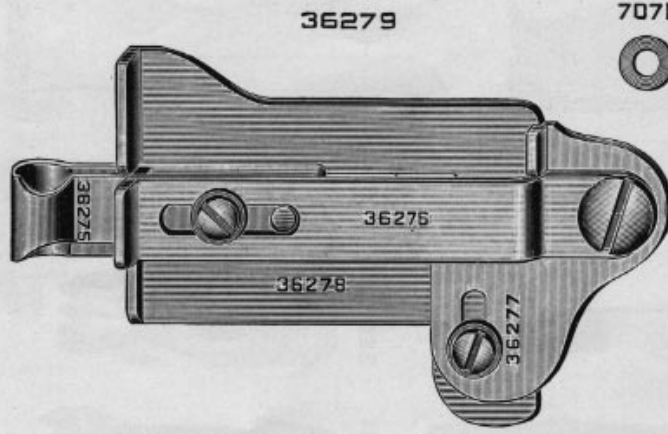
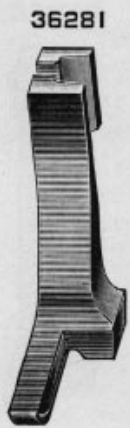
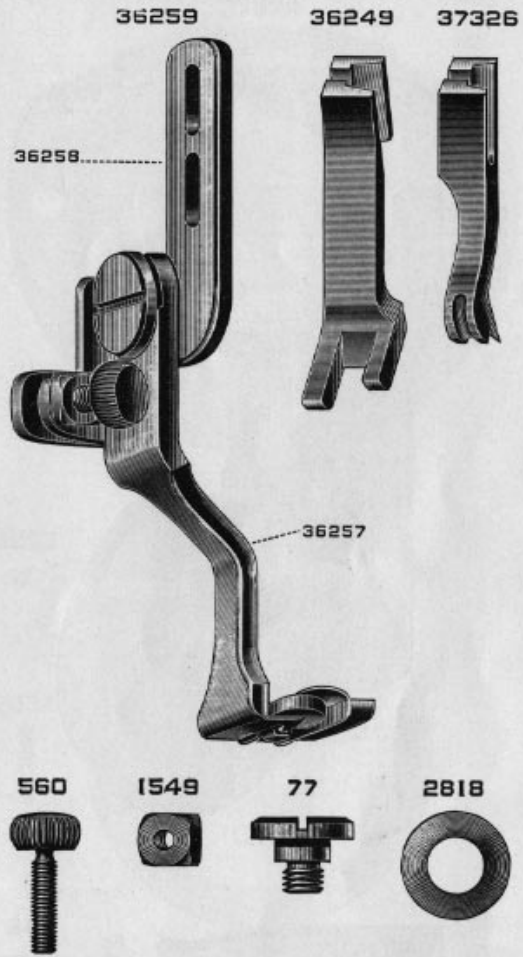
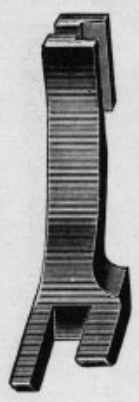


PLATE 6132—FULL SIZE

PLATE 6133—FULL SIZE



36264



37326



36263

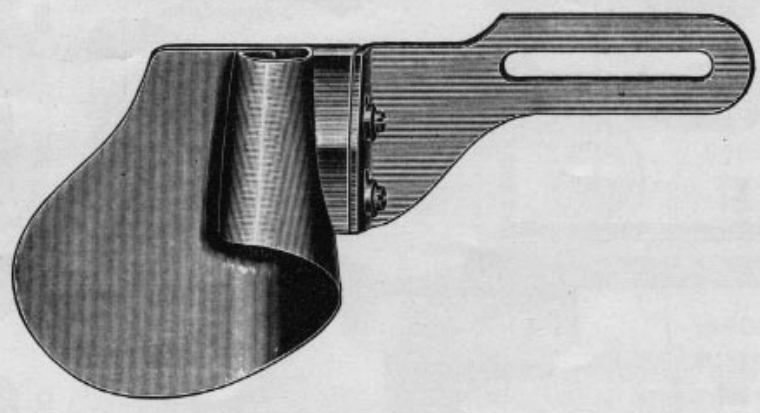


PLATE 6134—FULL SIZE

36264



37326



36265

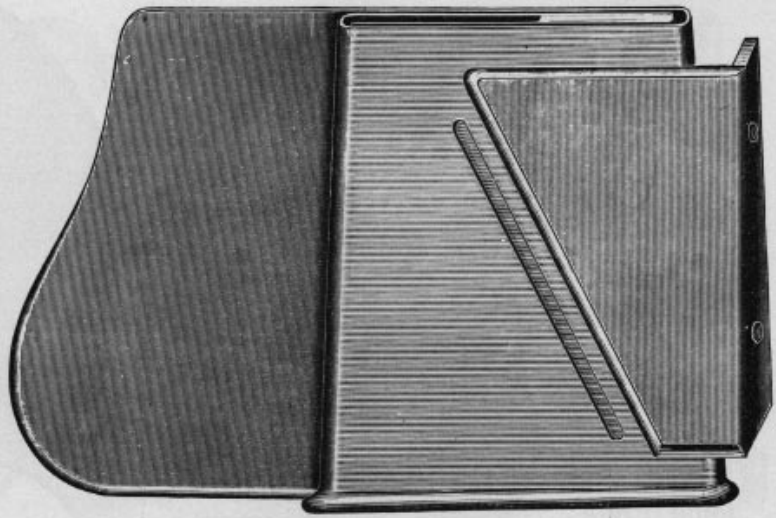
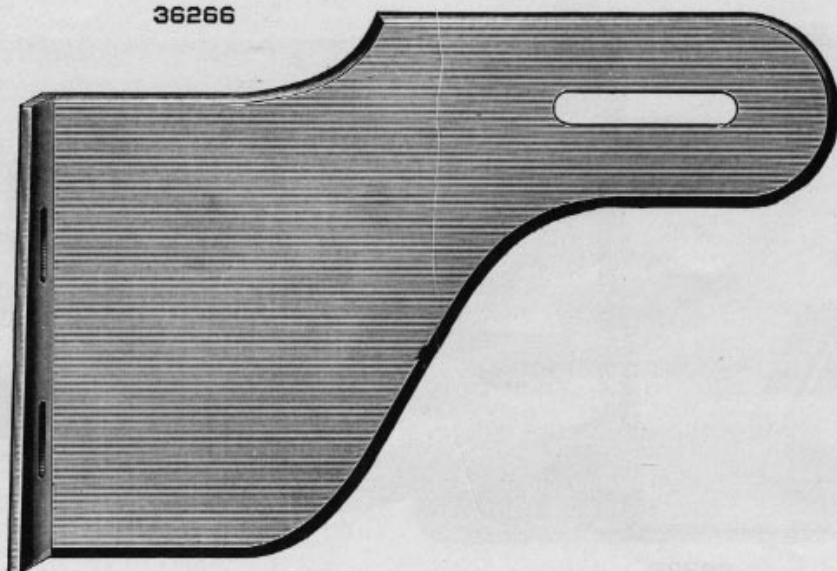


PLATE 6135—FULL SIZE

36266



230

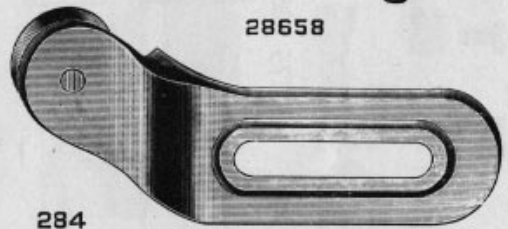
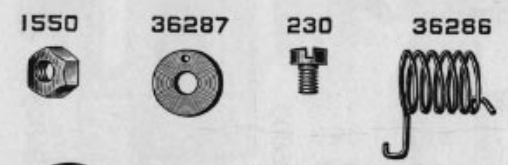
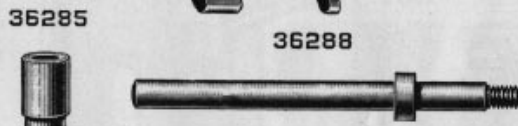
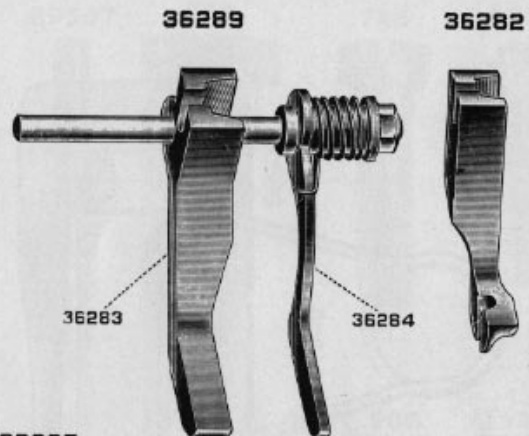


8068



PLATE 6136—FULL SIZE

PLATE 6137—FULL SIZE



36253



37326



51809



207



233



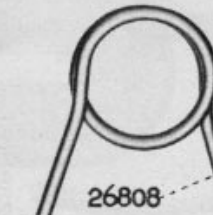
220



2362



36291



12152



94

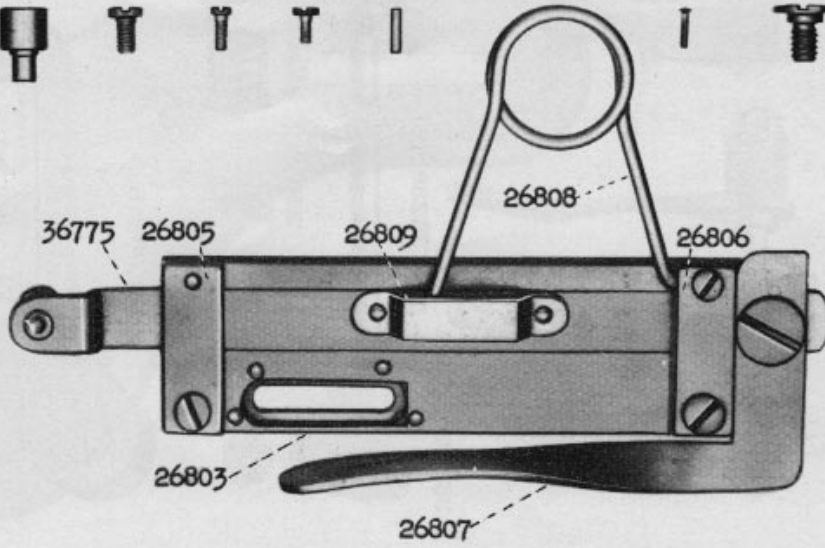


PLATE 6139 - FULL SIZE

PLATE 6143-FULL SIZE

29507



854



748



12454



8582



11119



52045



908



144



37307



430



896



448



219



79



1619



2827



8505



29601



8879



4430



PLATE 6144-ONE-HALF SIZE

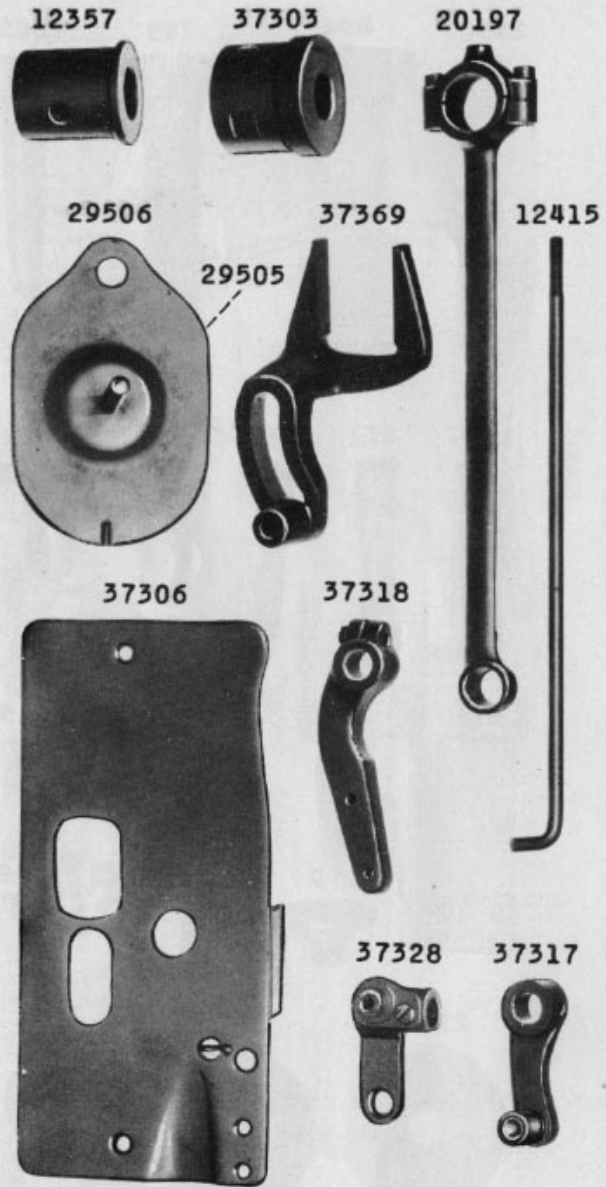
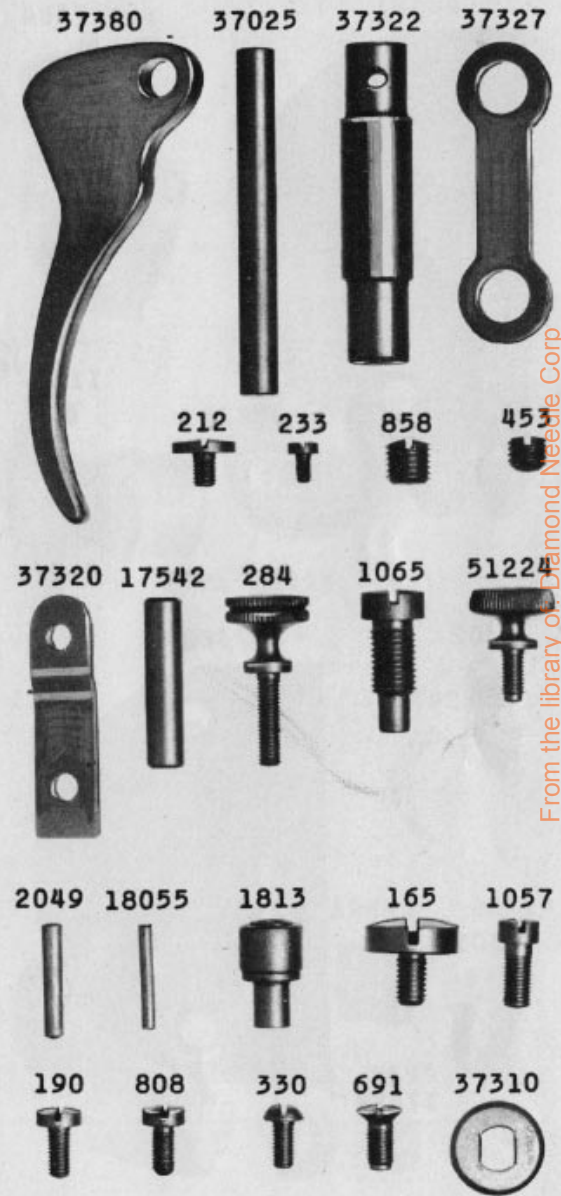
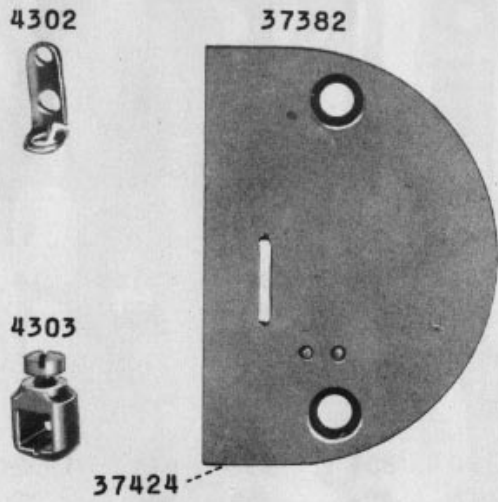
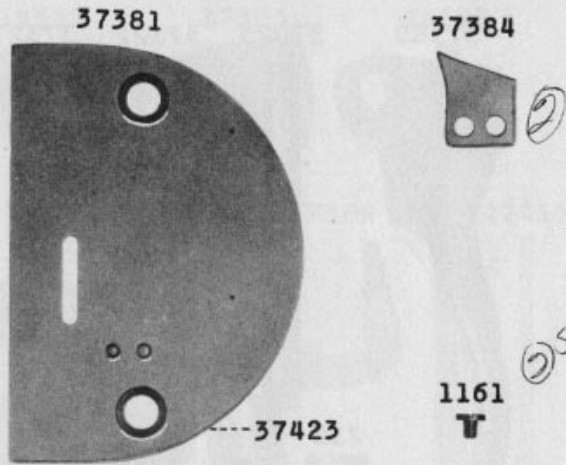


PLATE 6145-FULL SIZE



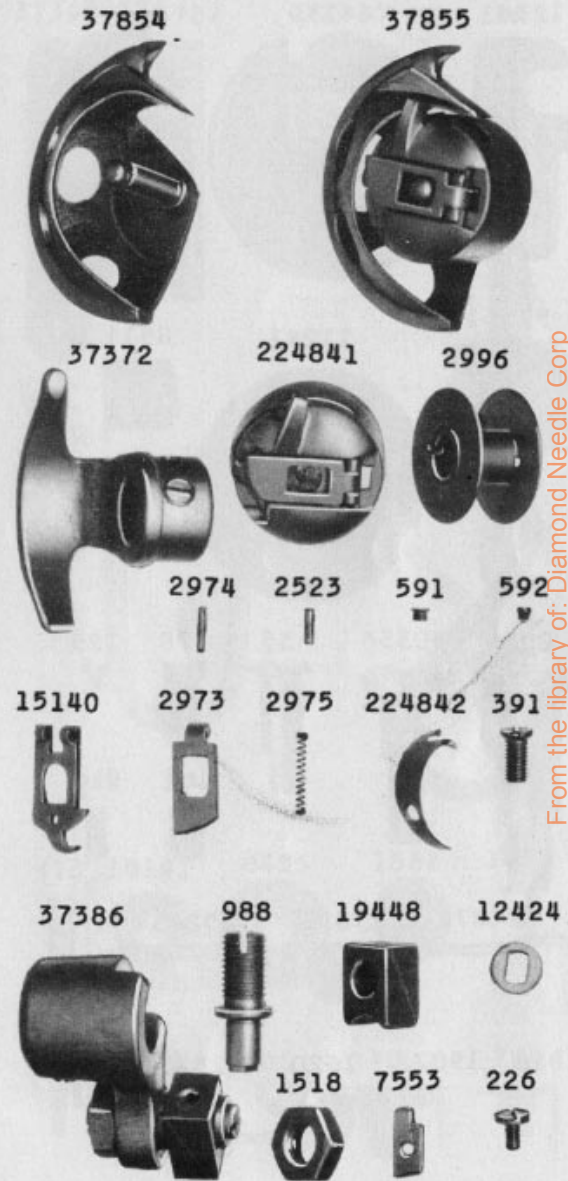
From the library of Diamond Needle Corp

PLATE 6147-FULL SIZE



2 screws

PLATE 6148-FULL SIZE



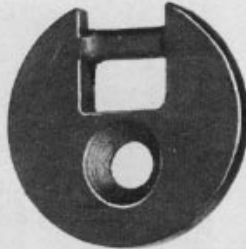
From the library of: Diamond Needle Corp

PLATE 6150-FULL SIZE

12361



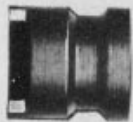
44139



12405



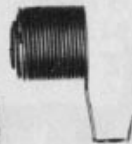
37351



11241



8511



802



50356



35



178



725



446



910



24078



27850



52454



41828



15072



1620



1521



PLATE 6151-FULL SIZE

37390



4727



12416



356



5601



56864



56865



4879



418



10141



2455



1562



7806



220



233



2106



76



766



From the library of: Diamond Needle Corp

PLATE 6154-ONE-FOURTH SIZE

37377



44212



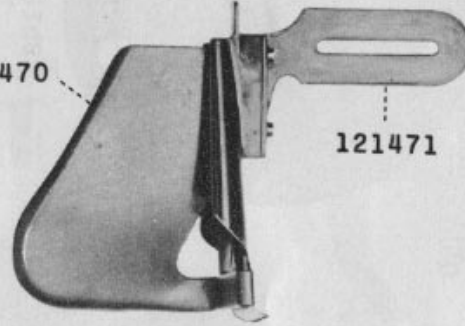
4370



PLATE 6156-ONE-HALF SIZE

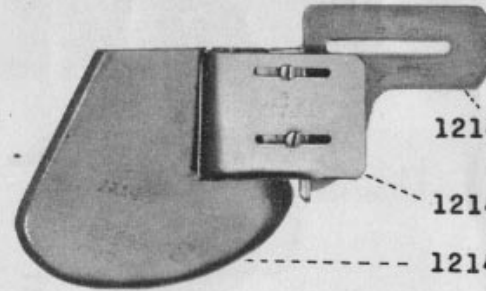
121472

121470



121471

121495



121494

121493

121492

From the library of: Diamond Needle Corp

PLATE 6157-FULL SIZE

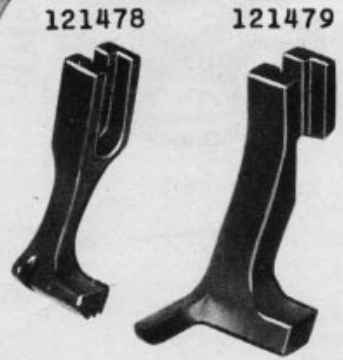
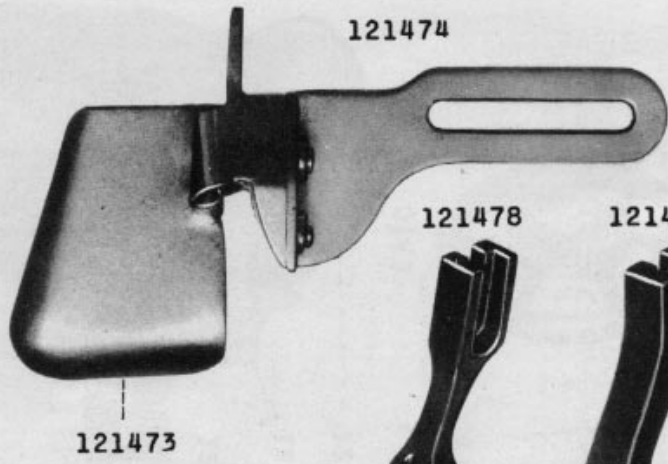
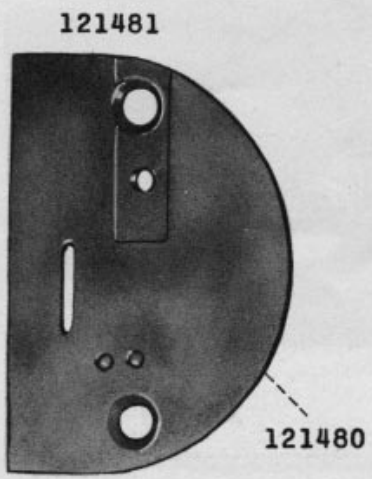


PLATE 6158-FULL SIZE

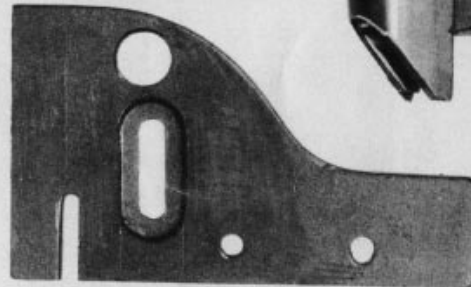
1442 25617 26486 121475



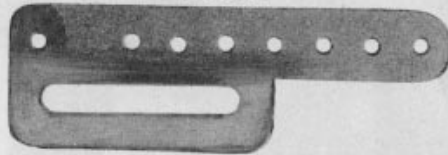
50004



121476



26618



25734

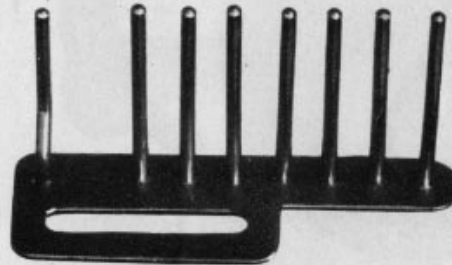


PLATE 6159-FULL SIZE

121482



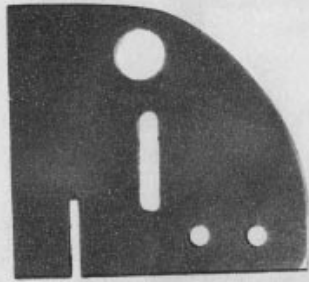
207



228



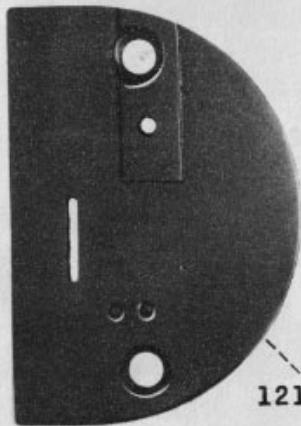
121483



36232



121486



36233



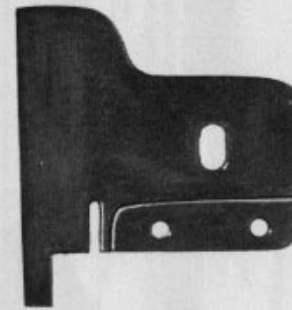
121485

PLATE 6160-FULL SIZE

121487



121488



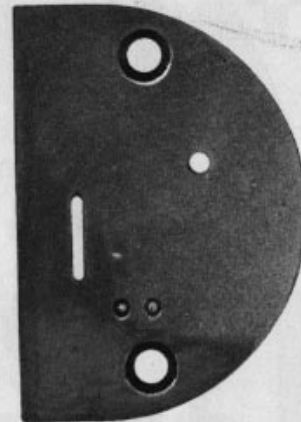
50163



1423



121491



121490

From the library of: Diamond Needle Corp

PLATE 6161 - FULL SIZE

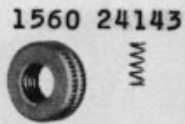
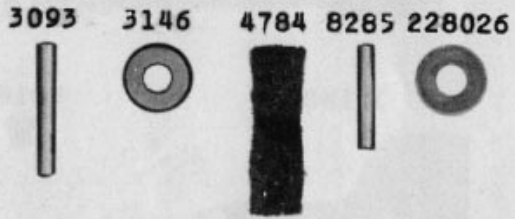
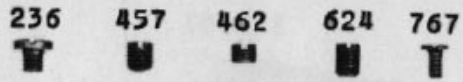
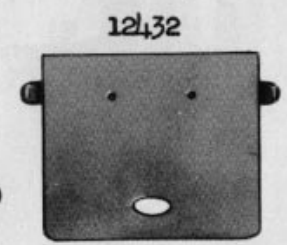
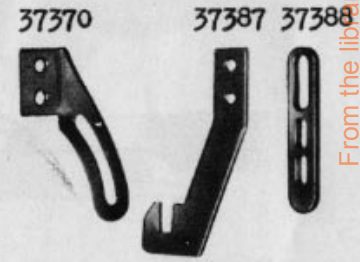
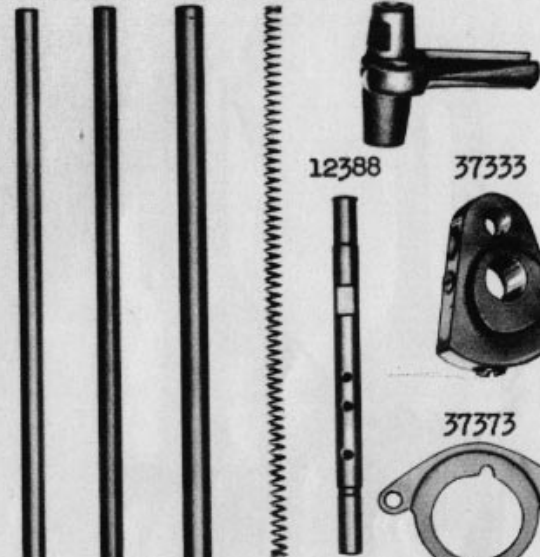
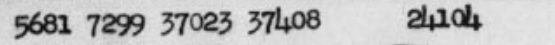


PLATE 6162 - ONE-HALF SIZE



From the library of: Diamond Needle Corp

PLATE 6163 - FULL SIZE

37421



37422



36412

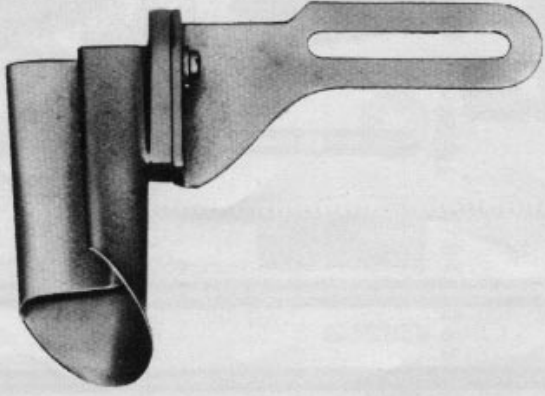


PLATE 6164 - FULL SIZE

37326



36253



121554

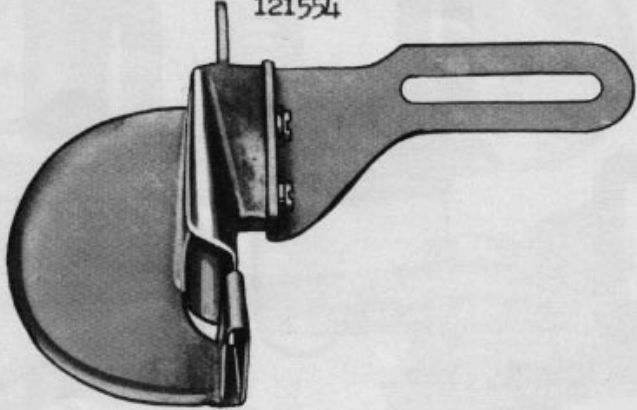


PLATE 6165 - ONE-HALF SIZE

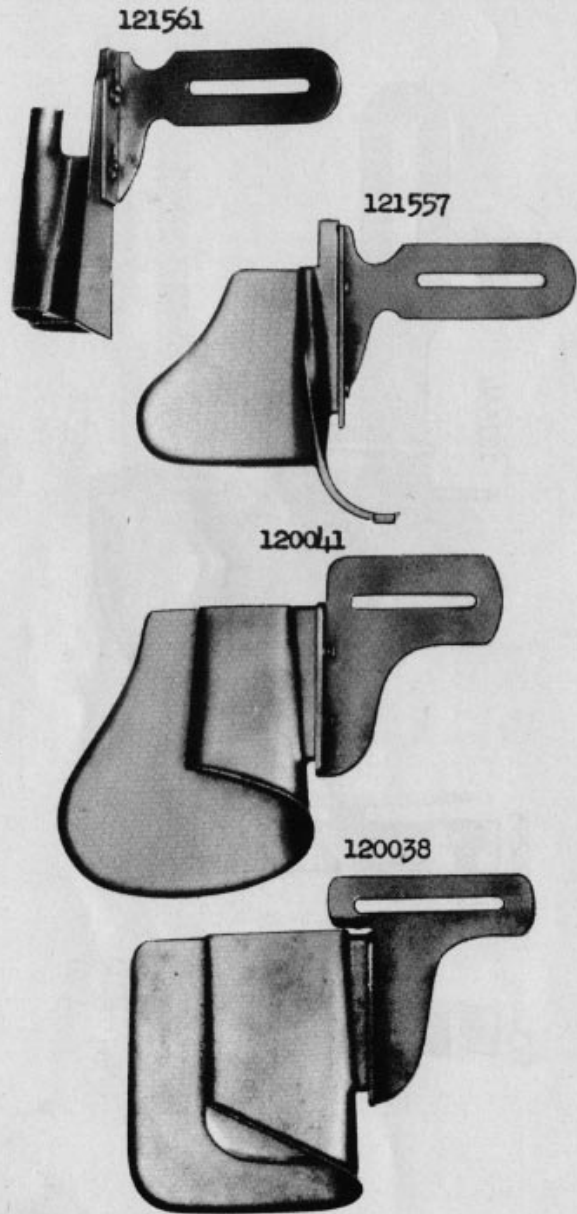
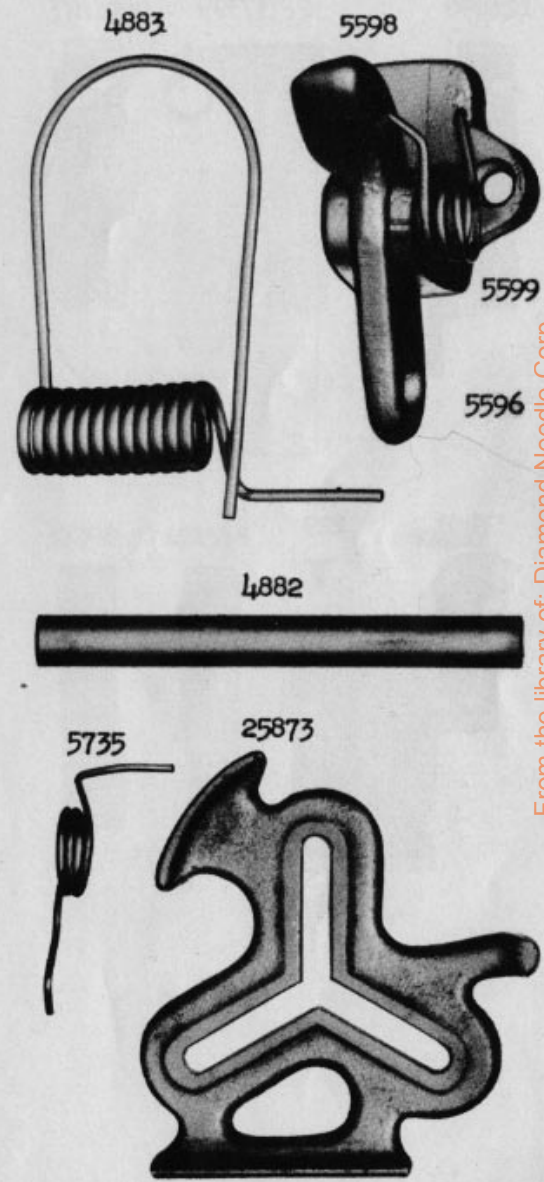


PLATE 6166 - FULL SIZE



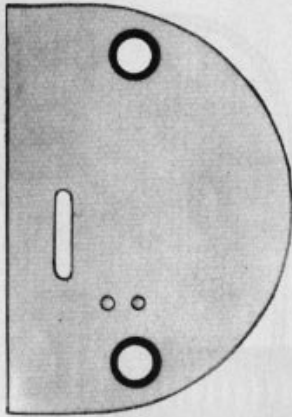
From the library of: Diamond Needle Corp

PLATE 6167 - FULL SIZE

121496



37399



37401



229



PLATE 6168 - FULL SIZE

37419



37354



37397



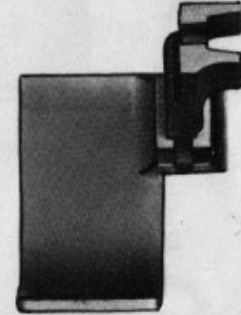
37398



121558

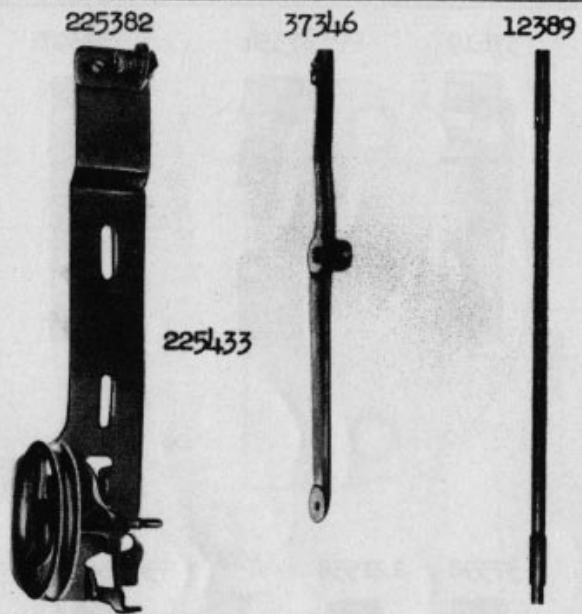


37416



From the library of: Diamond Needle Corp

PLATE 6169 - ONE-FOURTH SIZE

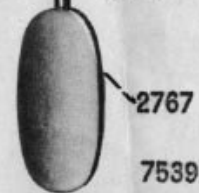
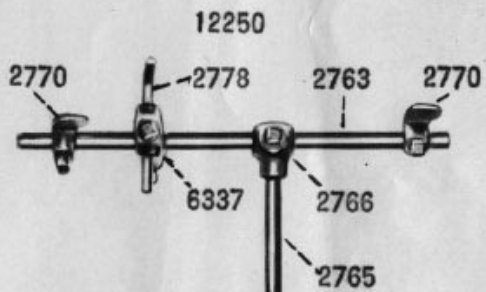
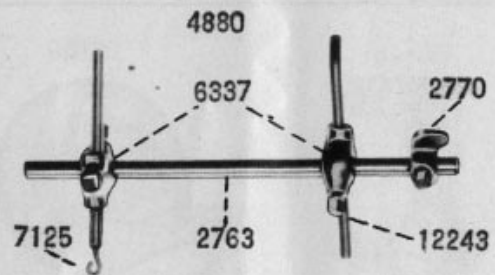


4881

4884



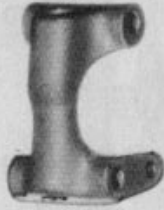
PLATE 22161 - ONE-FOURTH SIZE



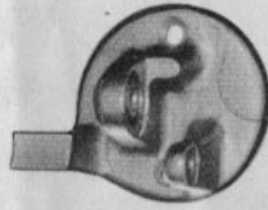
From the library of: Diamond Needle Corp

PLATE 22395 - ONE - HALF SIZE

225453



27540



27312



11241



225381



27538



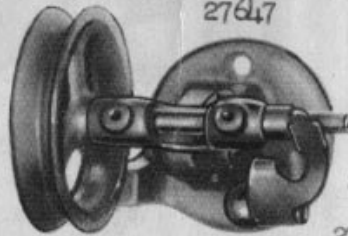
27541



27302



27647



27308



27306

27307